

FEASIBILITY STUDY OF SUPERCONDUCTING LSM ROCKET LAUNCHER SYSTEM

Kinjiro Yoshida, Takaaki Ohashi, Katsuto Shiraishi, Hiroshi Takami
 Depart. of Electrical Eng., Faculty of Eng., Kyushu University
 6 - 10 - 1 Hakozaki Higashi - ku, Fukuoka 812 JAPAN

S12-33

11920

P. 15

SUMMARY

A feasibility study is presented on an application of superconducting linear synchronous motor (LSM) to a large - scale rocket launcher, whose acceleration guide tube of LSM armature windings is constructed as far as the depth of 1,500 meters under the ground. The rocket is released from the linear launcher just after it gets to a peak speed of about 900 kilometers per hour, and flies out the guide tube to obtain the speed of 700 kilometers per hour at the height of 100 meters above the ground. The linear launcher is brought to a stop at the ground surface for a very short time of 5 seconds by a quick control of deceleration. Very large current variations in the single - layer windings of LSM armature which is produced at the higher speed region of 600 to 900 kilometers per hour are controlled successfully by adopting the double - layer windings. The proposed control method makes the rocket launcher ascend stably in the superconducting LSM system, controlling the Coriolis force.

INTRODUCTION

As matters stand today, to build space infrastructures, the crew and the materials can be transported only by means of a rocket. Available rockets are loaded with liquid fuel which occupies 80% - 90% of the total weight for only a few percents of the payload. The cost of space transportation is extremely high¹. By substituting superconducting LSM for the first acceleration step, the weight of liquid fuel can be greatly reduced and the payload transported at a time can be increased to a great extent. It is also expected to repeat ascending operations at much lower cost.

A feasibility study is presented on an application of a superconducting linear synchronous motor (LSM) to a large - scale rocket launcher facility with the acceleration guide tube of about 1,500 meters deep under the ground. The LSM armature windings are installed all along the acceleration guide tube and can drive in the vertical direction and guide in the horizontal direction the linear launcher vehicle, in which the superconducting magnets are mounted in the front and rear portions. A basic configuration of the linear launcher is a cylinder, in which the rocket is contained and connected through a passive suspension.

The computer program for simulating the basic operations of a superconducting LSM rocket launcher which is subjected to the Coriolis force has been developed in our Laboratory. Dynamics simulations ascending the 4 ton - vehicle with a 1 ton - rocket are obtained to meet a given acceleration pattern of quick acceleration and deceleration rate^{2,3} by using the novel control method of the mechanical load angle and the armature currents, which have been

proposed by the authors⁴. The rocket is released at a peak speed of about 900 kilometers per hour, flies out the guide tube and achieves the speed of 700 kilometers per hour at the height of 100 meters above the ground. On the other hand, the linear launcher is stopped for a very short time of 5 seconds by a quick control of deceleration. In the single-layer windings of the LSM armature, very current variations are produced at the speed regions of 600 to 900 kilometers per hour². This is caused by higher harmonic variations of the thrust forces due to the space harmonics of the armature windings. This problem is solved successfully by adopting the double-layer winding arrangement.

SUPERCONDUCTING LSM ROCKET LAUNCHER SYSTEM

Figure 1 shows a concept of a large-scale superconducting LSM-controlled rocket launcher system, which has the acceleration guide tube about 1,500 meters deep under the ground. The concept is based on our theoretical works on a superconducting LSM-controlled ground-based zero-gravity facility with the drop shaft of about 800 meters^{5,6}. In figure 1, the LSM armature windings installed all along the acceleration guide tube are used to drive and guide the linear launcher.

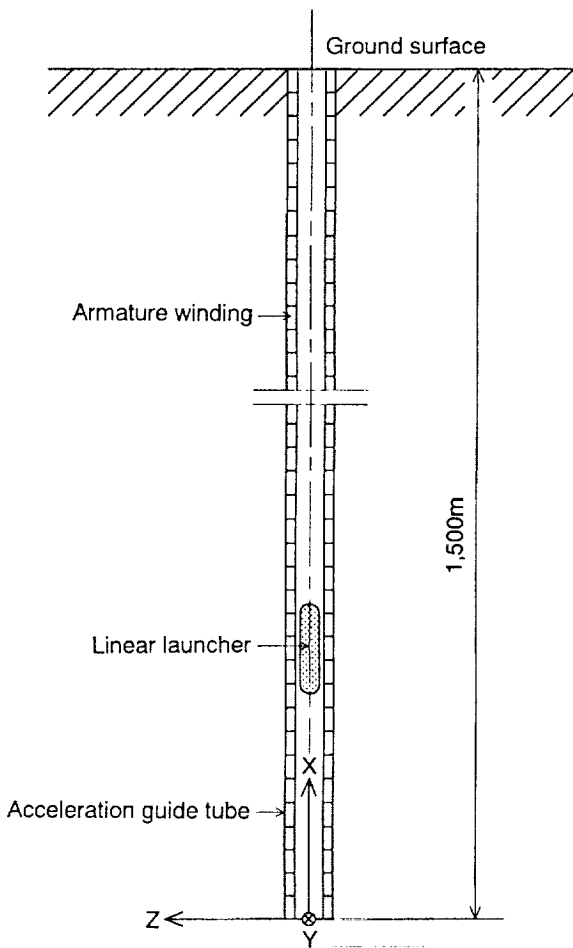

Figure 1. Vertical type superconducting - LSM controlled rocket launcher system.

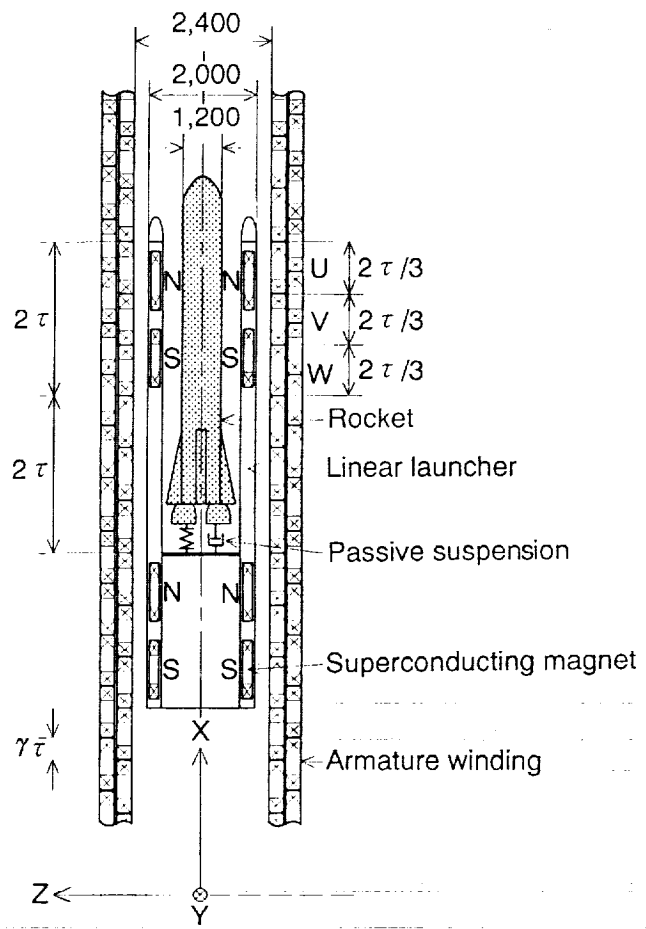

Figure 2. Acceleration guide tube of LSM armature and rocket launcher with superconducting magnets.

Figure 2 shows double-layer windings of the LSM armature which are composed of inside and outside coils, and the linear launcher on which the rocket is mounted through the use of passive suspension. The superconducting magnets are arranged with two poles facing the armature windings in the front and rear portions of a linear launcher vehicle.

Figure 3 shows a cylindrical configuration of the LSM launcher system which has four LSM's in symmetrical positions to produce guidance forces in the Y and Z directions. In the figure, the linear launcher is deflected by ΔY in the Y direction and by ΔZ in the Z direction. Inside and outside coils of each LSM armature are connected in series and each LSM is controlled independently using each current of their coils.

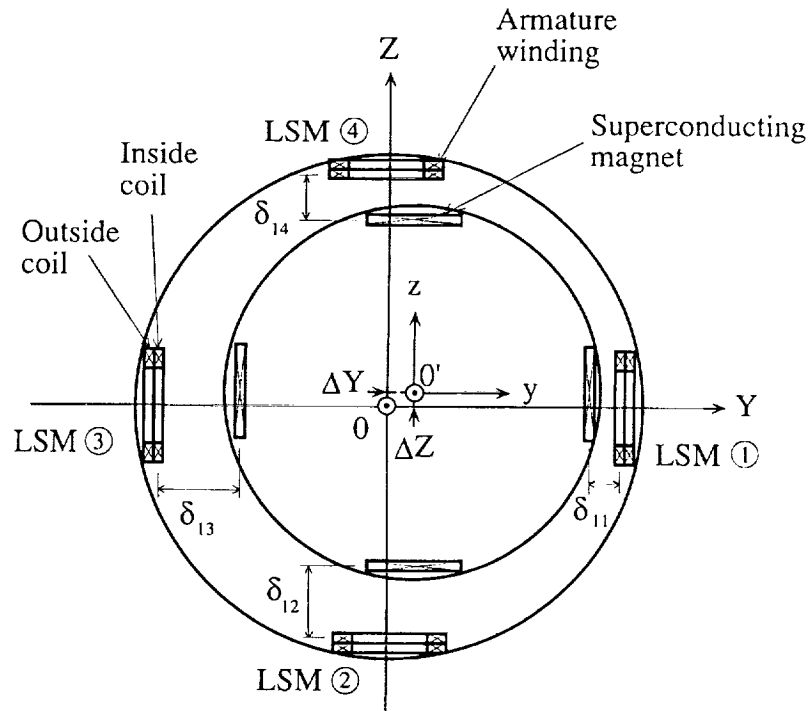

Figure 3. Model for analysis of rocket launcher.
(Cross-section of acceleration guide tube and four LSM's.)

THREE - DIMENSIONAL FORCE CALCULATION

For an arrangement of the four superconducting LSM's shown in figure 3, each LSM can be also treated independently from the viewpoint of force calculation. According to figure 2, the superconducting magnets in a front part of the linear launcher almost do not couple with those in the rear part. The force calculation is thus essentially reduced to an analysis of the LSM with 2-pole-superconducting magnets. Field solution for the air-core system, which includes the superconducting magnets, can be obtained analytically by using the law of Biot-Savart. The three-dimensional forces of thrust force F_X , lateral force F_Y and vertical force F_Z are expressed in an analytical form, which move the linear launcher in the X, Y and Z directions, respectively, in figure 3. By making each summation of X, Y and Z components of all forces in the four LSM's, resultant force F_X is applied as driving and braking forces, and resultant

forces F_Y and F_Z are used effectively as guiding forces.

EQUATIONS OF MOTION

Ascending Motion of Linear Launcher and Rocket

The linear launcher is accelerated to a peak speed, with loading the rocket, and after releasing the rocket, it is decelerated with no-load to be brought to rest at the end of the guide tube near the earth's surface. On the other hand, during the acceleration phase, the rocket is fixed to the launcher through a passive suspension, but after separating from the launcher, it ascends freely in the guide tube. The ascending motions in the X direction of the launcher and the rocket are described as follows :

$$\begin{aligned}
 M_L \frac{d}{dt} V_L = & F_{X,11}(I_{11}, X_0, \delta_{11}, \Delta Z) + F_{X,12}(I_{12}, X_0, \delta_{12}, \Delta Y) \\
 & + F_{X,13}(I_{13}, X_0, \delta_{13}, -\Delta Z) + F_{X,14}(I_{14}, X_0, \delta_{14}, -\Delta Y) \\
 & + F_{X,21}(I_{21}, X_0, \delta_{21}, \Delta Z) + F_{X,22}(I_{22}, X_0, \delta_{22}, \Delta Y) \\
 & + F_{X,23}(I_{23}, X_0, \delta_{23}, -\Delta Z) + F_{X,24}(I_{24}, X_0, \delta_{24}, -\Delta Y) \\
 & - M_L G - F_{dL} + k_s \Delta H + k_d \Delta v
 \end{aligned} \tag{1}$$

$$M_R \frac{d}{dt} V_R = - M_R G - F_{dR} - k_s \Delta H - k_d \Delta v \tag{2}$$

where

- M_L = linear launcher mass
- M_R = rocket mass
- V_L = speed of launcher
- V_R = speed of rocket
- $F_{X,ij}$ = thrust forces in the X direction
- I_{ij} = winding currents of armature
- X_0 = mechanical load angle defined by leading position of travelling magnetic field with moving superconducting - magnet
- δ_{ij} = electrical airgap between coil centers of superconducting - magnet and armature
- F_{dL}, F_{dR} = aerodynamic drag forces acting on launcher and rocket⁷
- k_s, k_d = spring and damping coefficients of passive suspension
- $\Delta H, \Delta v$ = relative height and speed of rocket with launcher
- G = acceleration of gravity

Note that i denotes the i th LSM (see figure 3) and j the j th layer coil of double-layer windings, with the 1st and the 2nd coils corresponding to inside and outside layer coils, respectively.

After the linear launcher launches the rocket, the motion of the linear launcher is described by equation (1) from which the last two terms of $k_s\Delta H$ and $k_d\Delta v$, *i.e.* the coupling terms between motions of the launcher and the rocket, are excluded. The rocket flies away freely in the LSM guide tube according to the equation of motion, which is mentioned in the following section.

Guidance Motion of Linear Launcher and Rocket

The linear launcher and rocket are guided in the Y - Z plane, shown in figure 3, by the resultant lateral force F_Y and the resultant vertical force F_Z which are produced and controlled in the four LSM's. The Coriolis force is an external disturbance force for the launcher system which depends on the launcher and rocket speeds. When the Z axis is assumed to be in an eastward direction, the Coriolis force can be taken into account in equations of the Z - directed motions of the linear launcher and the rocket. The guided motions are described in the following.

Guidance Motions of the Launcher

During the acceleration phase, the Y - directed motion is

$$\begin{aligned}
 (M_L + M_R) \frac{d}{dt} \Delta \dot{Y} = & - F_{Z,11} (I_{11}, X_0, \delta_{11}, \Delta Z) + F_{Y,12} (I_{12}, X_0, \delta_{12}, \Delta Y) \\
 & + F_{Z,13} (I_{13}, X_0, \delta_{13}, -\Delta Z) - F_{Y,14} (I_{14}, X_0, \delta_{14}, -\Delta Y) \\
 & - F_{Z,21} (I_{21}, X_0, \delta_{21}, \Delta Z) + F_{Y,22} (I_{22}, X_0, \delta_{22}, \Delta Y) \\
 & + F_{Z,23} (I_{23}, X_0, \delta_{23}, -\Delta Z) - F_{Y,24} (I_{24}, X_0, \delta_{24}, -\Delta Y) \quad (3)
 \end{aligned}$$

The Z - directed motion is

$$\begin{aligned}
 (M_L + M_R) \frac{d}{dt} \Delta \dot{Z} = & F_{Y,11} (I_{11}, X_0, \delta_{11}, \Delta Z) + F_{Z,12} (I_{12}, X_0, \delta_{12}, \Delta Y) \\
 & - F_{Y,13} (I_{13}, X_0, \delta_{13}, -\Delta Z) - F_{Z,14} (I_{14}, X_0, \delta_{14}, -\Delta Y) \\
 & + F_{Y,21} (I_{21}, X_0, \delta_{21}, \Delta Z) + F_{Z,22} (I_{22}, X_0, \delta_{22}, \Delta Y) \\
 & - F_{Y,23} (I_{23}, X_0, \delta_{23}, -\Delta Z) - F_{Z,24} (I_{24}, X_0, \delta_{24}, -\Delta Y) \\
 & - (M_L + M_R) G - (M_L + M_R) \Omega V_L \cos \Phi \quad (4)
 \end{aligned}$$

where Ω = Angular speed of revolution of the earth
 Φ = Angle of terrestrial latitude

After the linear launcher launches the rocket, during the deceleration phase, the Y - and Z - directed motions are described by using the equations (3) and (4) in which the mass M_L of the launcher itself is changed for the mass $(M_L + M_R)$.

Free Motion of the Rocket

After the rocket is released from the launcher and takes off with a high initial speed, the rocket continues to ascend with no control subject to the Coriolis force in the Z direction under the force of gravity in the X direction.

The free motion of the rocket is thus described as follows:
For the X - directed motion,

$$M_R \frac{dV_R}{dt} = -M_R G - F_{dR} \quad (5)$$

For the Y - directed motion,

$$M_R \frac{d}{dt} \Delta \dot{Y}_R = 0 \quad (6)$$

For the Z - directed motion,

$$M_R \frac{d}{dt} \Delta \dot{Z}_R = -M_R \Omega \Delta \dot{Z}_R \cos \Phi \quad (7)$$

Armature Current Control Method

The effective value of armature currents I_{ij} ($i=1,2, j=1,\dots,4$), which are included in equations (1), (3) and (4), are controlled to meet the given acceleration pattern. Below the launch speed, I_{ij} is given by

$$\begin{aligned} \left. \begin{array}{l} I_{11} \\ I_{21} \end{array} \right\} &= G_1(\alpha_{L0} - \dot{V}_L) + G_2(V_{L0} - V_L) + G_3(X_0 - X_\tau) - G_4|\Delta Z| \\ &\quad - G_5|\Delta \dot{Z}| + G_6\Delta Y + G_7\Delta \dot{Y} + I_{10} \end{aligned} \quad (8)$$

$$\begin{aligned} \left. \begin{array}{l} I_{12} \\ I_{22} \end{array} \right\} &= G_1(\alpha_{L0} - \dot{V}_L) + G_2(V_{L0} - V_L) + G_3(X_0 - X_\tau) - G_4|\Delta Y| \\ &\quad - G_5|\Delta \dot{Y}| - G_6\Delta Z - G_7\Delta \dot{Z} + I_{10} \end{aligned} \quad (9)$$

$$\begin{aligned} \left. \begin{array}{l} I_{13} \\ I_{23} \end{array} \right\} &= G_1(\alpha_{L0} - \dot{V}_L) + G_2(V_{L0} - V_L) + G_3(X_0 - X_\tau) - G_4|\Delta Z| \\ &\quad - G_5|\Delta \dot{Z}| - G_6\Delta Y - G_7\Delta \dot{Y} + I_{10} \end{aligned} \quad (10)$$

$$\begin{aligned} \left. \begin{array}{l} I_{14} \\ I_{24} \end{array} \right\} &= G_1(\alpha_{L0} - \dot{V}_L) + G_2(V_{L0} - V_L) + G_3(X_0 - X_\tau) - G_4|\Delta Y| \\ &\quad - G_5|\Delta \dot{Y}| + G_6\Delta Z + G_7\Delta \dot{Z} + I_{10} \end{aligned} \quad (11)$$

where I_{10} = Demand stationary current
 α_{L0} = Demand acceleration of launcher

- V_{L0} = Demand synchronous speed of launcher
 X_{τ} = Demand mechanical load angle
 $\Delta\dot{Y}, \Delta\dot{Z}$ = Launcher speeds in the Y and Z directions
 $G_1 \sim G_7$ = feedback gains

At the same time, the linear launcher should be controlled to ascend at the synchronous speed V_{X0} of the travelling magnetic field by producing the LSM thrust F_X . The mechanical load angle is controlled for all four LSM's to produce the sufficiently strong repulsive force in the resultant guidance forces F_Y and F_Z . When the launcher receives any disturbance forces in the Y and Z directions, the LSM guidance forces can compensate automatically and keep it at the center of the four LSM's.

Above the launch speed, I_{ij} is given by the equations which are obtained only by changing the negative sign for the positive sign in the first three terms of equations (8) - (11).

NUMERICAL EXPERIMENTS

The superconducting LSM rocket launcher system (see Table 1) is designed for the 1-ton rocket to attain a speed of 700 kilometers per hour at the height of 100 meters above the ground. In the limited length of the LSM armature guide tube, the linear launcher is controlled to meet the designed acceleration pattern, which has the 6.6-second acceleration phase with a quick variation from zero to 4 G's for 0.5 seconds and 4 G's kept for 6.1 seconds, and the 4.67-second deceleration phase with a very quick variation from 4 G's to -7.5 G's for 1.3 seconds, -7.5 G's kept for 2.87 seconds and a very quick variation from -7.5 G's to zero for 0.5 seconds.

Table 1. Superconducting LSM Rocket Launcher

Guide Tube :		Total weight	4 ton
Total length	1,500 m	No. of Superconducting Magnets	16
Diameter	4 m	Superconducting Magnets per one LSM :	
LSM Armature Guide Tube :		No. of poles	4
Total length	1,500 m	Coil length	1.3 m
Inside diameter	2.4 m	Coil width	0.5 m
Outside diameter	2.6 m	MMF	700 kAT
No. of LSM Armature	4	Pole pitch	1.5 m
Coil length	0.8 m	Rocket :	
Coil width	0.6 m	Total weight	1 ton
Linear Launcher :		Clearance Gap :	
Total length	9 m	Electrical gap between coil centers	20 cm
Diameter	2 m	Mechanical gap	10 cm

Effects of Double - Layer Armature Windings

Figure 4 shows armature current response for the controlled dynamics of the launcher, with a parameter of shifted length $\gamma\tau$ between inside and outside coils of the double - layer distributed winding. In figure 4 (a), with a case of $\gamma\tau=0$ m which corresponds to a single - layer of concentrated winding, very large current variations are caused in a higher speed range near the peak speed, and this means unstable and dangerous operation of the system. But it is found from figure 4 (a) - (d) that as the shifted length is increased, unstable current variations are damped and decreased, and in the case of $\gamma\tau=0.3$ m the small current variations with higher harmonics as well as the large current variations are almost eliminated. When the shifted length $\gamma\tau$ is increased above 0.3 m, the current variations are induced again, as shown in figure 4 (e).

Figure 5 shows thrust forces accelerating and decelerating the linear launcher. As apparently in figures 5 (a) and (b), the thrust forces due to inside and outside armature windings include small higher - harmonic forces and other unstable harmonic forces produced discontinuously. The resultant thrust force in figure 5 (c) almost eliminates their harmonic forces and shows a very smooth curve in all operating regions. Figure 6 shows a harmonics - eliminated curve and the corresponding resultant guidance - force component F_z due to inside and outside coils. In the following simulations, 0.3 m is thus used as $\gamma\tau$.

Simulated Motions of LSM Launcher and Rocket

Figures 7 (a) and (b) show that the rocket is released from the launcher just after the peak speed at the location of 1,000 m, launches with an initial speed of about 900 kilometers per hour, flies out the LSM guide tube with a speed of about 720 kilometers per hour and then attains the demand speed of 700 kilometers per hour at the height of 100 m above the ground.

An instance when the rocket is released is known from an instance for $\Delta H=0$ in figure 7 (h). As shown in figure 7 (c), the launcher follows very well the designed acceleration pattern according to the demand mechanical load angle in figure 7 (e).

Figure 7 (j) shows that the Coriolis force in the Z direction is compensated completely before a released point and after that the launcher itself is controlled quickly and stably in the center of the LSM guide tube while the rocket is deflected in the reverse direction of the Z axis, *i. e.* in the westward direction, by 3.8 cm at the flying - out point of the guide tube end. The deflection is sufficiently small compared with a mechanical clearance between the rocket and the inside coil of LSM armature, so that the rocket does not come into collision with the wall of the inside coils. Figure 7 (l) shows that the launcher oscillating motion in the Z direction is damped and the rocket is moved quite slowly in the westward direction, due to the Coriolis force.

CONCLUSIONS

The concept of a vertical type superconducting LSM rocket launcher system under the ground, in which the novel armature control method is successfully applied for the double - layer armature windings of the acceleration guide tube, is proposed and designed for a feasibility

study. The computer program for simulating controlled dynamics of the system is developed, which can take into account interesting and important effects of the Coriolis force.

If the rocket attains the speed of 700 kilometers per hour at the height of 100 m above the ground, the weight reduction of the liquid fuel enables the rocket payload to increase more than 15%. The superconducting LSM rocket launcher system which launches the 1-ton rocket is designed for that purpose. Simulated results show that, on the condition of the Coriolis force, the linear launcher and rocket ascend together, accelerated and guided stably in the center of the guide tube, as high as the released point of 1,000 meters. After their separation, the launcher is decelerated and controlled to be brought to a stop with compensation for the Coriolis force while, due to the Coriolis force, the decreasing rocket is moved slowly in the westward direction, but because of the nearly zero initial - speed of the well - guided launcher at the released point, even the maximum deflection at the flying - out position is so small that there are no collisions with the guide tube.

ACKNOWLEDGEMENTS

We appreciate the help of Sumiko Shibuta in preparing the manuscript.

REFERENCES

1. O'Neill, Gerard K. : The Low (Profile) Road to Space Manufacturing, Special Section of *Astronautics & Aeronautics*, March 1978.
2. Yoshida, K. ; Ohhashi, T. ; Noritomi, K. : Ascending - Control Simulation of Superconducting LSM Rocket Launcher, Proc. the 4th Sym. on Electromagnetic Force Applications, Kanazawa, June 1992, pp. 153 - 158.
3. Yoshida, K. ; Ohhashi, T. ; Shiraishi, M. ; Takami, H. : Effects of Double Layer Armature Windings on Controlled Dynamics of Superconducting LSM Rocket Launcher, Proc. the 5th Sym. on Electromagnetic Force Applications, Hitachi, June 1993, pp. 51 - 55.
4. Yoshida, K. ; Nagao, S. : Levitation and Propulsion Control Simulation of Regardless - of - Speed Superconducting LSM Repulsive Maglev Vehicle, Proc. the 3rd Sym. on Electromagnetic Forces, June 1991, pp. 201 - 206.
5. Yoshida, K. ; Kunihiro, A. : Drop Motion Control of Capsule in Superconducting LSM Controlled Ground - Based Zero - Gravity Facility , Proc. the Second Sym. on Electromagnetic Force Applications, Nagoya, June 1990, pp. 5 - 10.
6. Yoshida, K. ; Kunihiro, A. ; Ohhashi, T. : Superconducting LSM Dynamics in Ground - Based Zero - Gravity Facility, Proc. Inter. Conf. on the Evolution and Modern Aspects of Synchronous Machines, Zurich, Aug. 1991, Part 3, pp. 797 - 802.
7. Yamamoto, A. : Pressure Variations, Aerodynamic Drag and Tunnel Ventilation in Shinkansen Type Tunnel, Rail. Tech. Res. Rep., RTRI JNR, . No. 871, pp. 62 - 64 (1973).

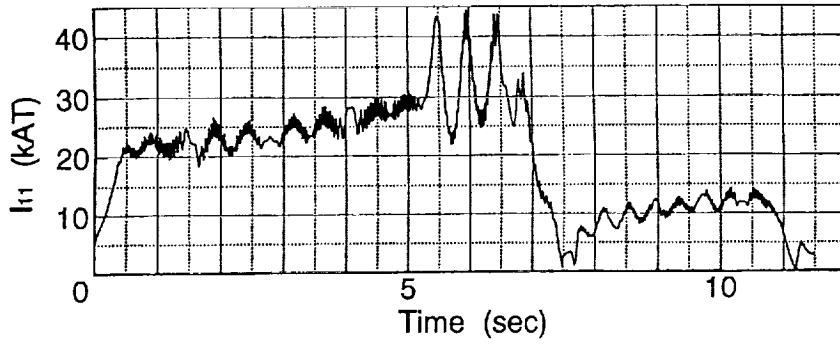

(a) $\gamma\tau = 0$ m

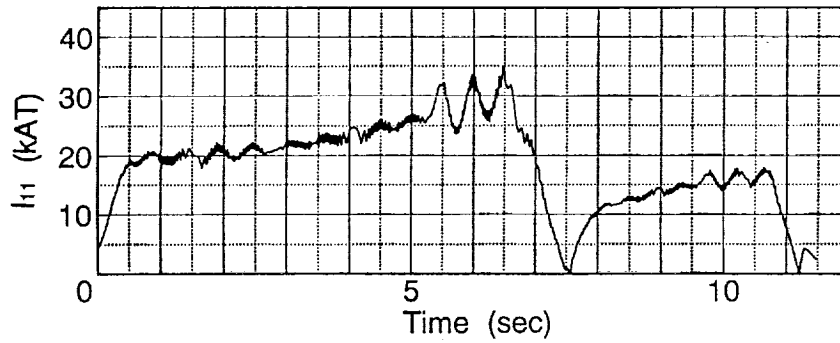

(b) $\gamma\tau = 0.15$ m

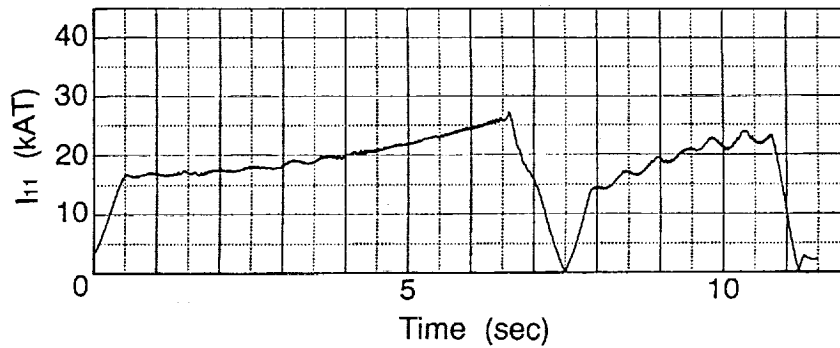

(c) $\gamma\tau = 0.30$ m

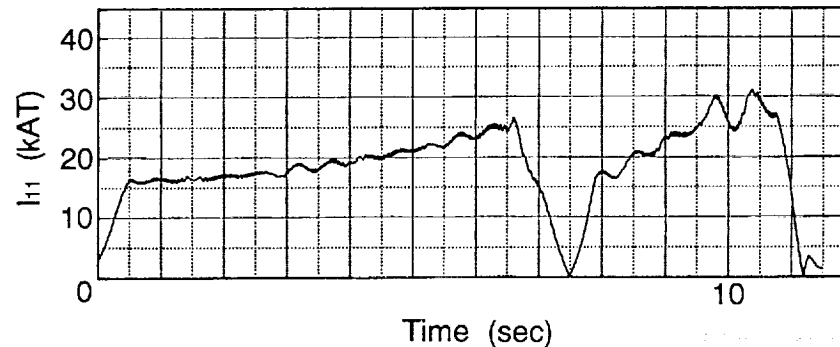

(d) $\gamma\tau = 0.35$ m

Figure 4. Currents of double-layer armature winding.

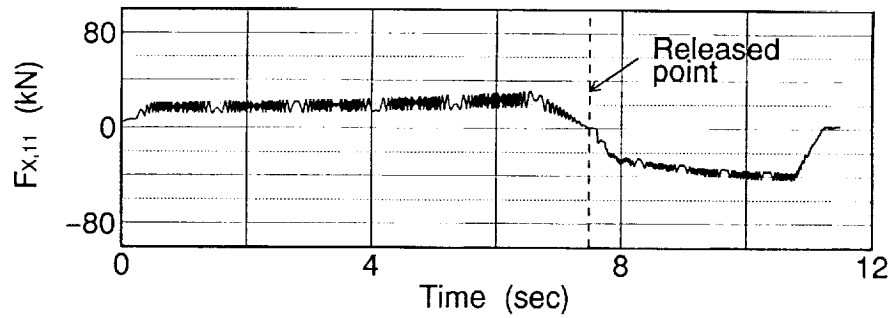

(a) Thrust force due to inside armature winding

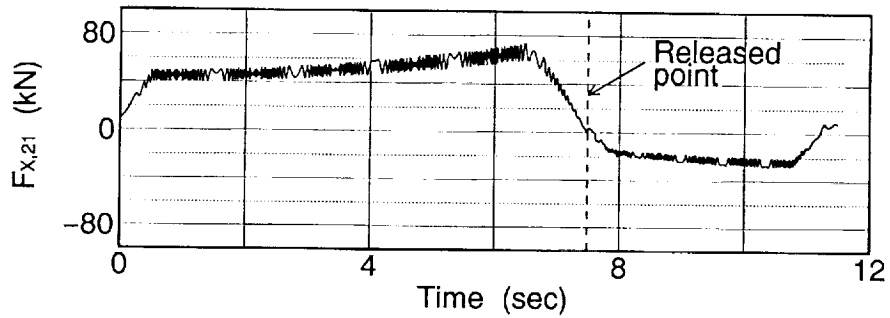

(b) Thrust force due to outside armature winding

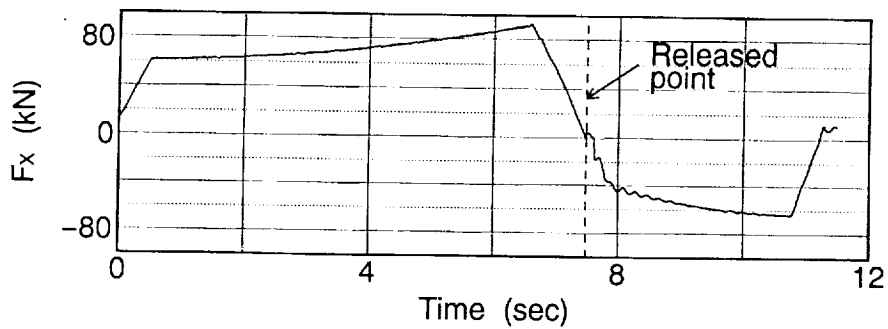

(c) Resultant thrust force

Figure 5. Thrust force due to inside and outside coils of armature windings and resultant thrust force.

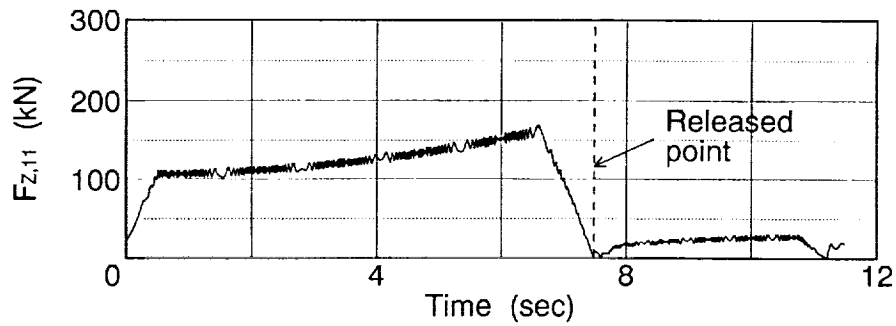

(a) Guidance force due to inside armature winding

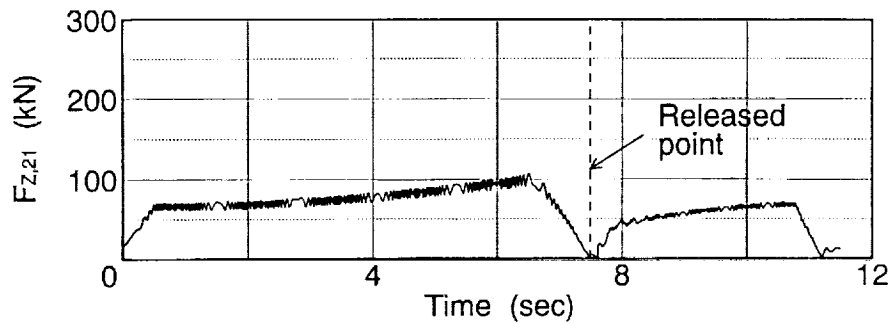

(b) Guidance force due to outside armature winding

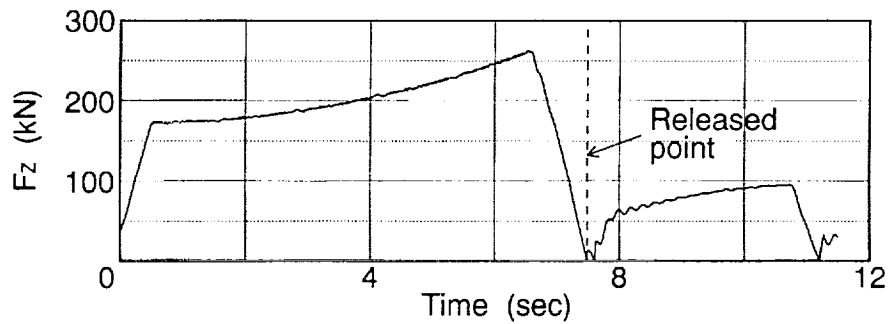

(c) Resultant force

Figure 6. Guidance forces due to inside and outside coils of armature windings and resultant Guidance force.

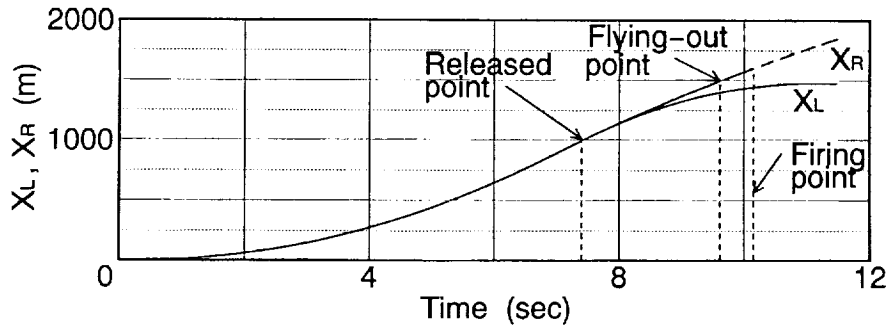

(a) Position of ascending launcher and rocket

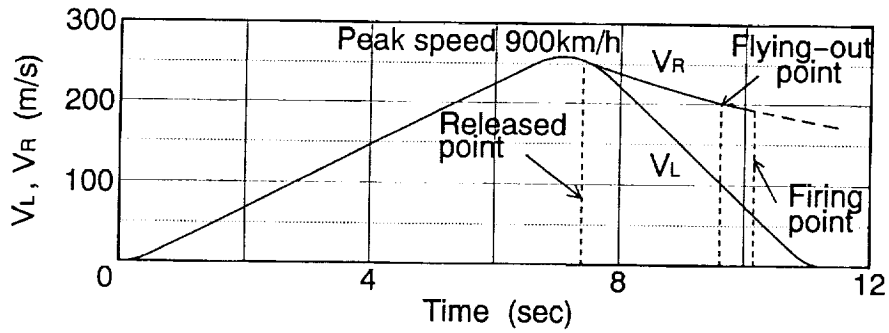

(b) Speed of ascending launcher and rocket

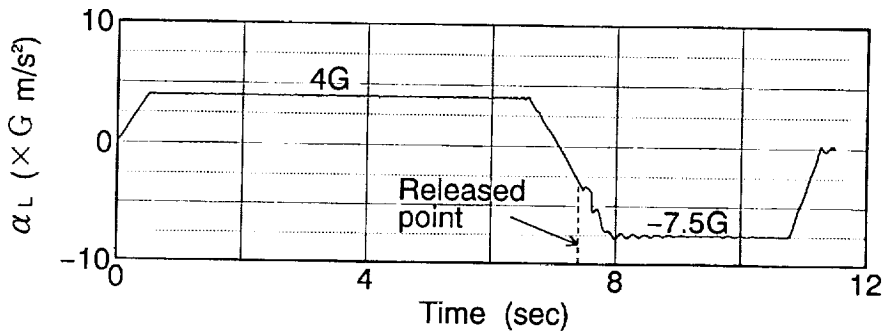

(c) Acceleration of ascending launcher

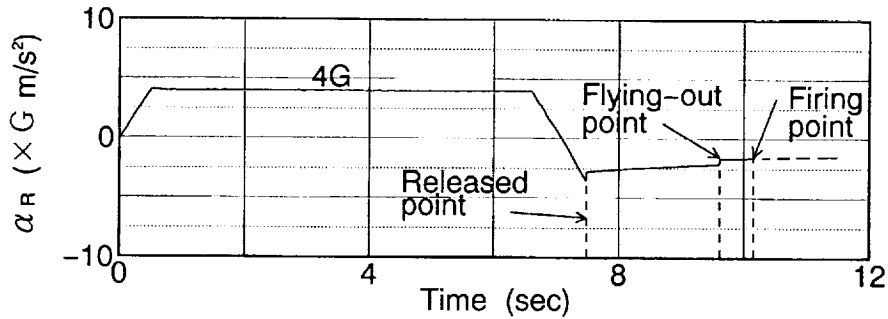

(d) Acceleration of ascending rocket

Figure 7. Ascending motion of LSM rocket launcher ($\gamma\tau = 0.3m$)

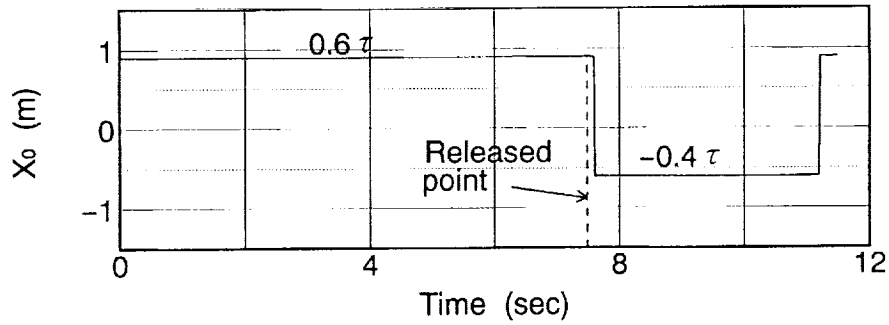

(e) Mechanical load angle

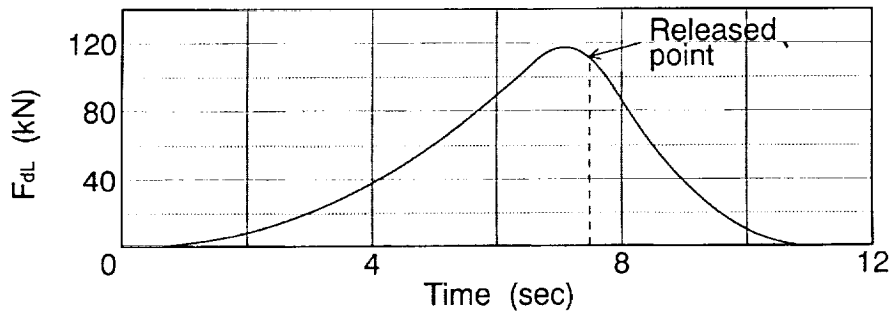

(f) Aerodynamic drag acting on launcher

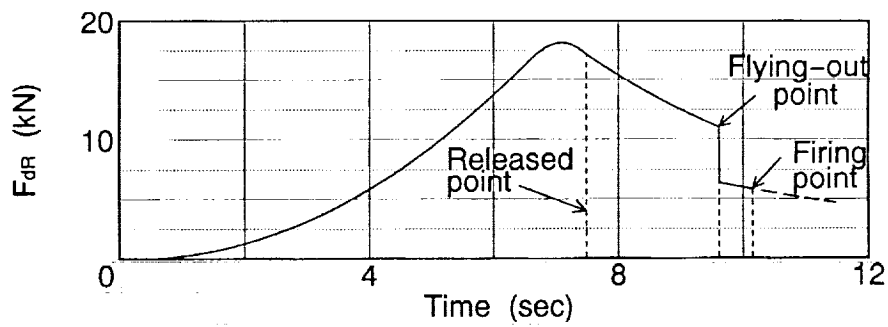

(g) Aerodynamic drag acting on rocket

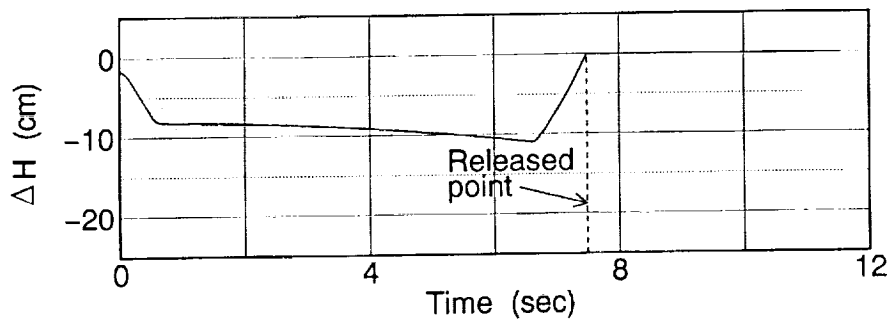

(h) Relative height between launcher and rocket

Figure 7. Ascending motion of LSM rocket launcher ($\gamma\tau = 0.3m$)

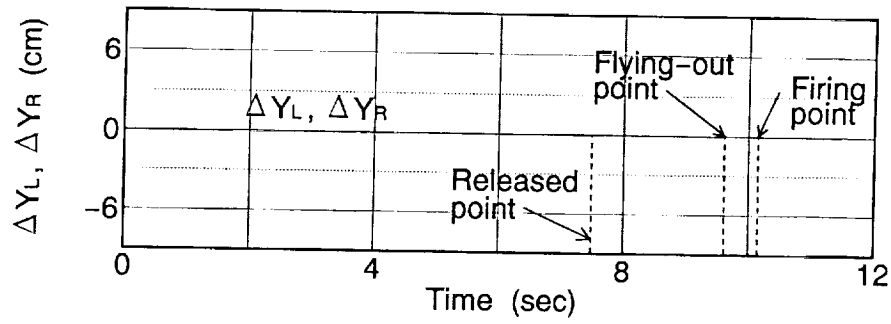

(i) Launcher and rocket deflections in the Y direction.

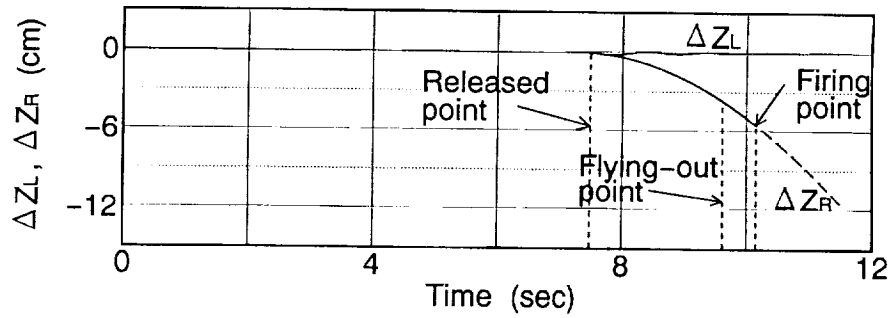

(j) Launcher and rocket deflections in the Z direction.

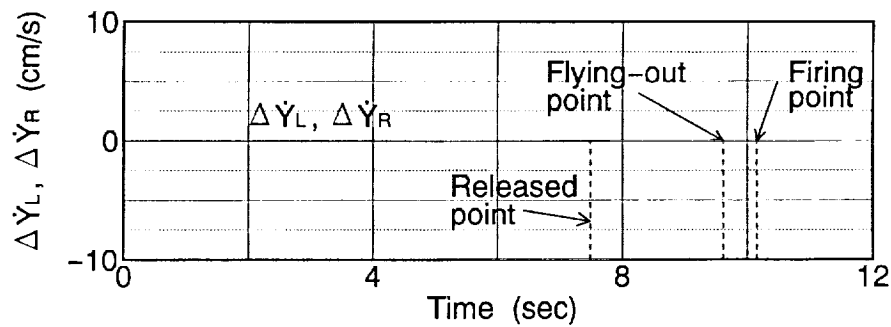

(k) Launcher and rocket speeds in the Y direction.

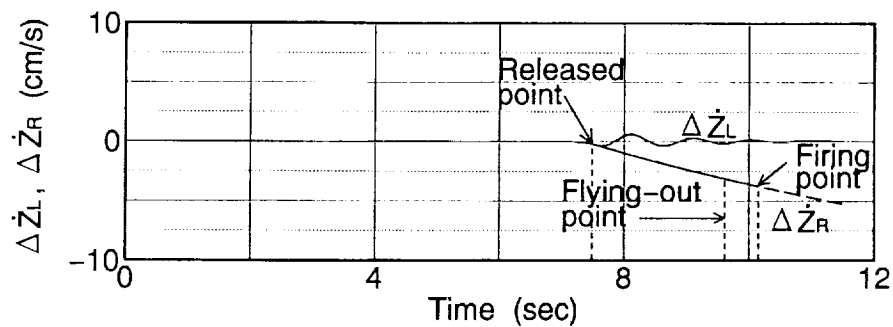

(l) Launcher and rocket speeds in the Z direction.

Figure 7. Ascending motion of LSM rocket launcher ($\gamma\tau = 0.3m$)