

STATUS OF MSBS STUDY AT NAL

Hideo Sawada and Hisashi Suenaga
National Aerospace Laboratory
7-44-1 Jindaijihigashi-machi Chofu-shi Tokyo
182, Japan

Takayuki Suzuki and Nobukazu Ikeda
Musashi Institute of Technology
1-28-1 Tamatutumi Setagayaku Tokyo
Japan

SUMMARY

Two Magnetic Suspension and Balance Systems (MSBS) at the National Aerospace Laboratory (NAL) in Japan are introduced. They are 10cm MSBS and 60cm MSBS. They have 10cm x 10cm and 60cm x 60cm test sections. The control of suspending a model at the 10cm MSBS is the 6 degrees of freedom including the rolling moment control. The model for the rolling moment control has two pairs of small extra permanent magnets at both its ends plus a main cylindrical magnet. The rolling moment is generated by the magnetic forces acting on the extra magnets by controlled current passing through the four side coils independently. Test results show the roll angle of the model is controlled in this way. The dynamic calibration test was carried out at the MSBS in 5 degree of freedom without the rolling moment control. The model is a simple cylindrical magnet magnetized along its axis. The obtained results show that the dynamic calibration with measured magnetic field intensity is much superior to that with the coil currents. The 60cm MSBS was designed with some data obtained at the 10cm one. It is fundamentally proportional to the 10cm one in size and coils position. The measured magnetic field intensity is not so strong as expected at design. It was operated first in 1993. The control is 3 degree of freedom in the longitudinal direction. The size of it is the largest one in the world presently.

INTRODUCTION

The MSBS is a very attractive instrument of the wind tunnel testing technologies because it can provide the support interference free test data and so on. However, only several MSBS's have been operated in the wind tunnel tests in some countries (ref. 1). The maximum one was the 40 cm x 60 cm in its test section at Russia (ref. 2). Primitive study was started at NAL about 8 years ago to build a practical sized MSBS in the future. The 10cm MSBS was built in 1985 and was operated first in 1987 (ref. 3). It has been improved in many points since that time. The purposes of the 10cm MSBS were to examine the way of designing it and to get a way of designing a larger one and to gain experience in operating it. Some fundamental data relating to

the MSBS have been obtained with it. The 60cm MSBS was designed and built with the data. It has been operated in the 3 degree of freedom since March in 1993. It is the largest one in the world in size as shown in Figure 1. The two MSBS's and some test results which have been obtained through the study of them are introduced in this paper.

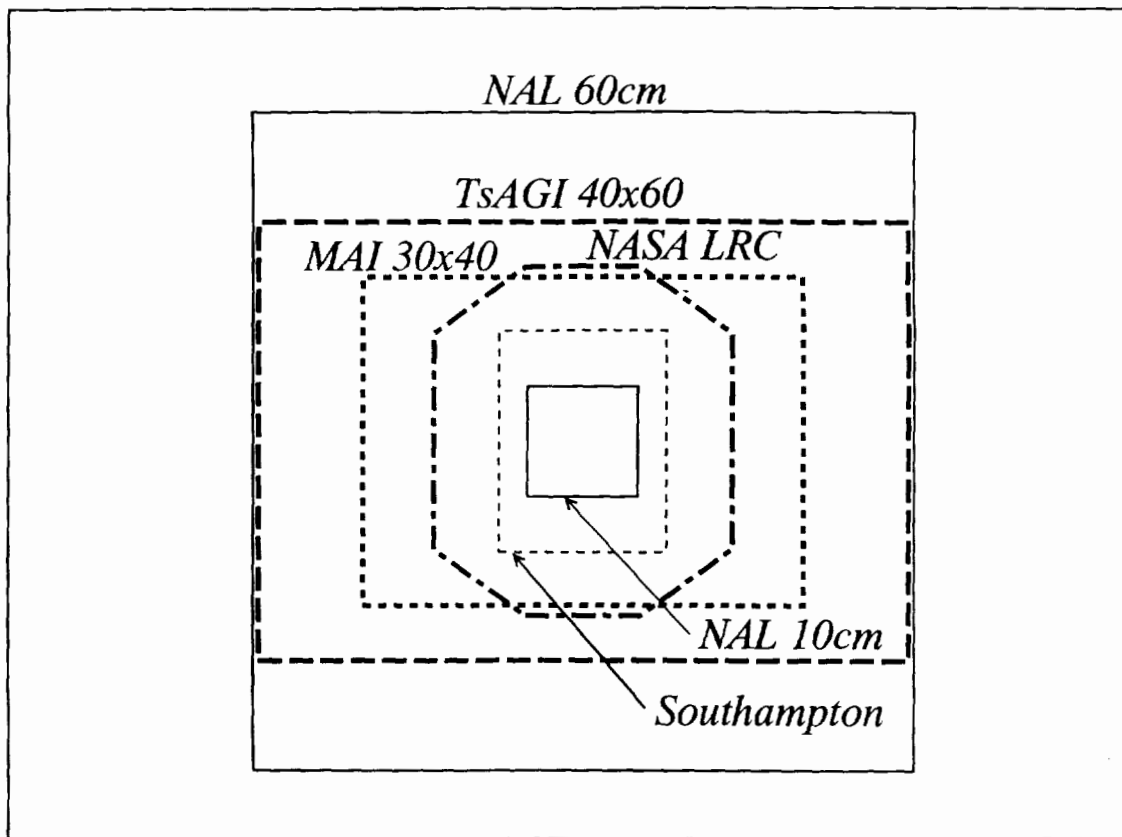

Figure 1. Test section size of large MSBS's

Symbols

- H magnetic field intensity. (H_x, H_y, H_z)
 H_z ave. averaged H_z
- m_i magnetic charge. ($i = 1, \dots, 8$) See Figure 5.
 mt magnetic moment of extra magnets. See Figure 5.
 r distance to the extra magnets from model center. See Figure 5.
 w distance to coil end from x axis. See figure 5.
 x coordinate in the direction of centerline of test section. The x axis is on the horizontal plane. See Figure 2
 y coordinate in the perpendicular to xz plane. See Figure 2.
 z coordinate in the normal direction to the horizontal plane.
 (x, y, z) coordinate system. Origin is located at the point across the symmetrical plane of the MSBS and the x axis.
 ϕ roll angle of model. See Figure 5.
 mg gravity force acting on a model.

10cm MSBS

System Description

Coil Arrangement

The 10cm MSBS has 8 iron cored coils and 2 air cored coils as shown in Figure 2. The 8 coils are arranged in the axial symmetry with respect to the x axis. All coils are placed symmetrically with respect to the yz plane at $x = 0$. The coils are numbered as shown in the figure and identified with their number in this paper. The dimensions of the coils are listed in Table I. A wind tunnel test section is placed through the two air cored coils along the x axis. A part of the section wall is made of transparent plastic. The position of a model inside it can be measured with the model position sensor through this part as shown in the figure.

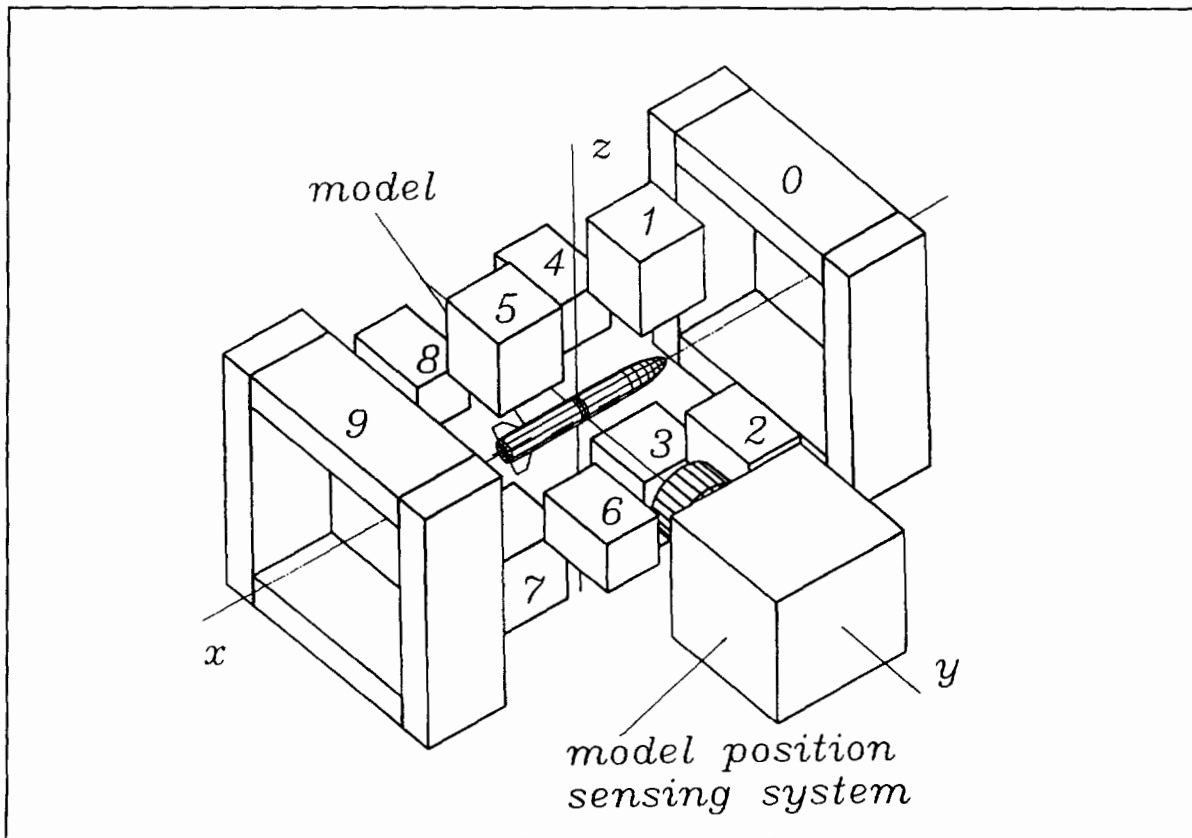

Figure 2. Coil arrangement at the NAL's MSBS's

The two air cored coils generate $\partial H_x / \partial x$. The magnetic force in the x direction (drag) acts on a permanent magnet magnetized in the x direction with the $\partial H_x / \partial x$. They are called drag coils for their purpose in this paper. Similarly, the coils of 1, 3, 5 and 7 are called lift coils. The coils of 2, 4, 6 and 8 are also called side coils in this paper. Currents passing through the lift coils generate H_z . The $\partial H_z / \partial x$ generates the magnetic force in the z direction (lift) acting on the model magnetized uniformly in the x direction. The averaged H_z on the

model generates the magnetic moment about the y axis (pitching moment) acting on the model. The $\partial H_y / \partial x$ and the averaged H_y on the model generate the magnetic force in y direction (side force) and moment about the z axis (yawing moment) acting on the model. The magnetic moment about the x axis (rolling moment) will not be generated with the model magnetized in x direction. Some extra magnets magnetized perpendiculars to the model axis are attached for the rolling moment at the 10cm MSBS.

coil No.	turns	core size(mm)	purpose
0, 9	240	120 x 120 air cored	drag force
1, 3, 5, 7	200	50 x 50 iron cored	lift force pitching moment
2, 4, 6, 8	100	40 x 40 iron cored	side force yawing moment rolling moment

Table I. Dimensions of coils of the 10cm MSBS

Models

Each model for the 10cm MSBS has a cylindrical permanent magnet in it along its center line at least. The magnet is magnetized in its axial direction. Almost all magnets which have been used at the 10cm MSBS are Alnico. Models with a cylindrical magnet inside are controlled in the 5 degree of freedom without the rolling moment control. Two pairs of extra small magnets are placed at the main cylindrical magnet ends as shown in Figure 3. One pair of them is rotated by 90 degrees about the model axis to the other one. Two magnets of each are placed in the way of facing with the same kind of the pole. As a result, the extra magnets are Sm-Co ones to keep their high intensity of magnetization.

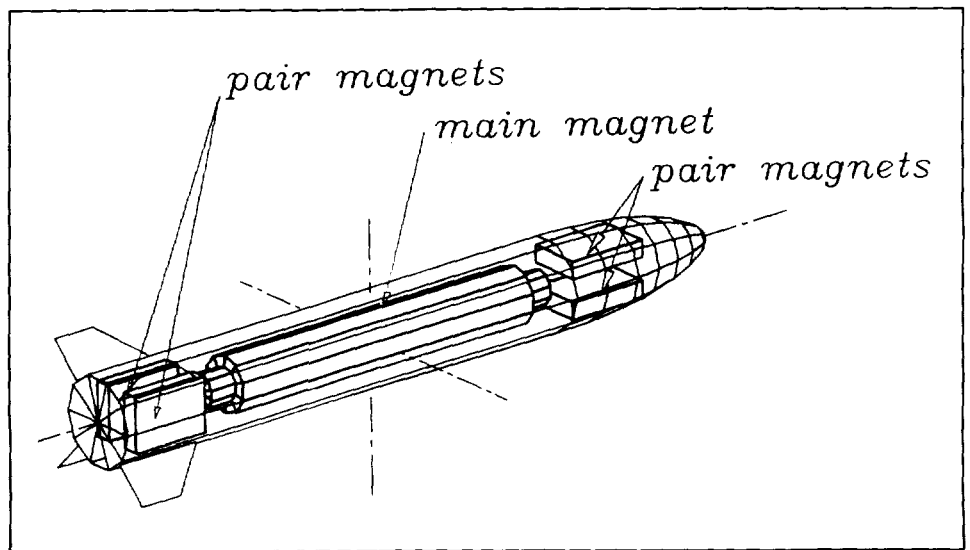

Figure 3. Magnet arrangement inside a model for rolling moment control

Besides those models, small simple cylindrical magnet models are tested at the 10cm MSBS to examine the control ability. The smallest one is 50 mm long and 6 mm in its diameter. The tested cored magnets and models are listed in Table II. The model length is limited by the measurable range of the model position sensing system.

shape	diameter	length	control	core magnet
Rocket type	16	150	6 degree	Alnico-5+Sm-Co
Rocket type	16	100	6 degree	Alnico-5+Sm-Co
cylinder	16	80	5 degree	Ferrite
cylinder	10	125	5 degree	Alnico-5
cylinder	8	80, 60, 50	5 degree	Alnico-5
cylinder	6	80, 60, 50	5 degree	Alnico-5

Table II. List of models at the 10cm MSBS

Model Position Sensing System

The model position sensors are developed at NAL. The features are reflection type and its rapid measurement. The image of a model is focused on a screen in the system with a lens. The model is painted in white and some marks are written on it in black. Three one dimensional CCD array sensors are placed in the letter H. The image of the model makes some dark and bright parts on the sensors according to the model position. The model position can be estimated accurately by counting the positions of the boundaries between the dark and bright parts on the arrays. The detail of the sensor is described in reference 4.

This system gives a feature to both MSBS's at NAL. It is in operation with the system. The model position can be controlled arbitrarily by changing the system position while it is kept at a constant position with respect to the system.

Power Supply

The power supply consists of 10 bipolar current control mode power units. The maximum current of the units is 15 A. The 2 units for the drag coils are different from the others a little. The maximum voltage of them is 20 V but that of the other ones is 18 V. All coils are provided with current by their independent power units. The power units are controlled by voltage signals from 10 DA converters. DC outputs for the current monitors in the units are available. Their accuracy is within 30 mA at most in their full range. The side coils are controlled with independent DA converters. The signals to control them are calculated to control the y direction translation, yawing motion, and rotation of the model.

Controller

The MSBS is controlled by a personal computer with Intel 486 of 20 MHz. The cycle of feedback control is 397 Hz and its timing signal is generated accurately by a crystal oscillator. The control algorithm is

the PI control plus double phase advance like the MSBS in reference 5. The coefficients of these control elements can be changed during its operation. The model position is displayed graphically in real time. A setpoint of it can also be changed both in step-like and continuous ways. The sinusoidal motion of the model is available. This mode was used in the dynamic calibration test.

Data Acquisition

Another personal computer is used for the data acquisition. The controller generates an interrupt signal to the data acquisition computer and also sends the model position data to it. The computer measures the current monitor output of the power units synchronistically with the controller. All data are stored in its memory in real time.

Measured Magnetic Field

The minimum distance between the two facing iron cored coils in the 10cm MSBS was 120 mm but it is 130 mm presently. The change was carried out in 1992 to make the test section removal easier. The distance between the drag coils became shorter by 40 mm to improve its drag force generation ability. The magnetic field intensity was measured in detail before the improvement. The whole magnetic field inside the 10cm MSBS is shown in Figure 4 although the measurement was carried out before the modification. It shows the well controlled magnetic field is generated in it.

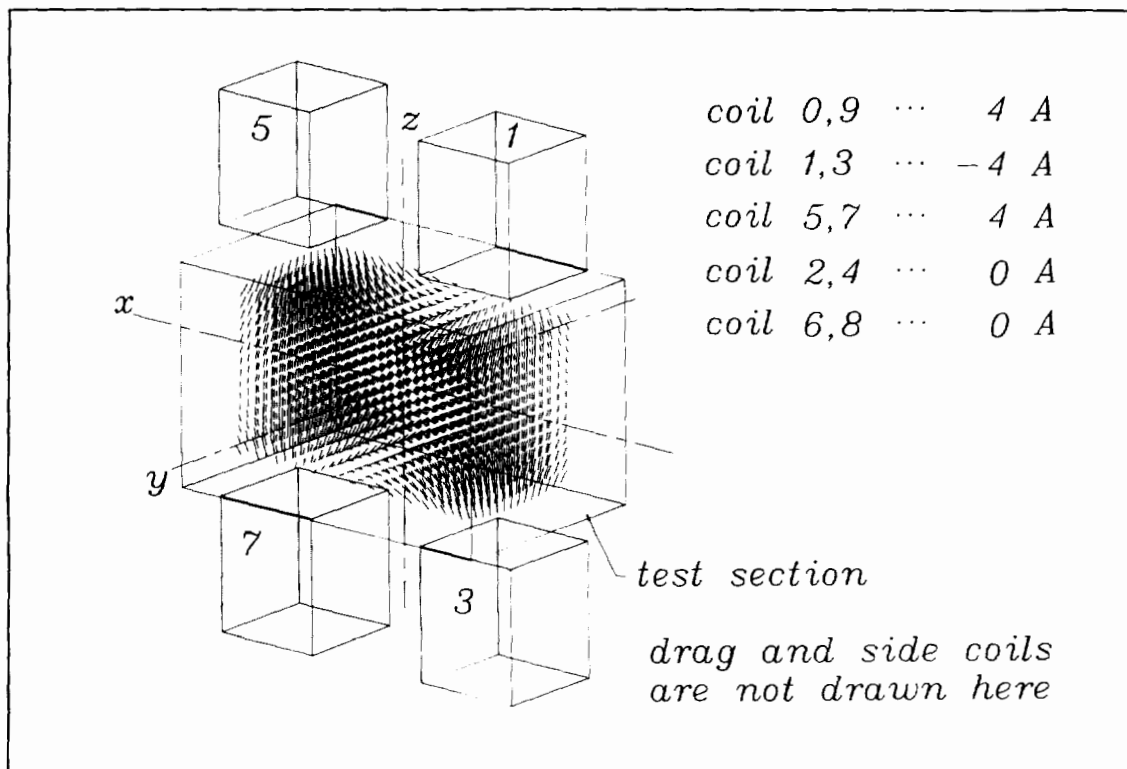

Figure 4. Measured magnetic field inside the 10cm MSBS

Wind Tunnel

A small supersonic wind tunnel of the blow down type was reformed as a wind tunnel for the MSBS. The test section size is 10 cm × 10 cm. A downstream part of the old contraction was replaced by a new one made of aluminum. The test section is also made of aluminum. Two windows are equipped on the side walls for the model position measurement. The maximum available flow speed is about 60 m/s. The flow uniformity in 60mm × 60 mm about the center line is good and its deviation is less than 1 % at $x = 0$. The turbulence intensity measured at the center with a hot wire is within 0.5% when the flow speed is less than 36 m/s. But the flow angle uniformity was found to be poor. As a result, this tunnel is used for examining the model suspension ability in the flow but not for measuring any aerodynamic test data.

Rolling Moment Control

Principle

The rolling moment can be controlled at the MSBS when a special model is used. The model contains the two pairs of extra magnets at both ends of a main magnet. The two magnets of each pair and the four iron cored coils surrounding an end of the model can be replaced by two magnetic moments and four magnetic charges in their effects as shown in Figure 5. Analytical estimation (ref. 6) shows that pure rolling moment acts on the model by placing the same polar magnetic charge at the two side magnet positions. The other forces and moments do not act on it. The estimated magnitude of the rolling moment is shown in Figure 6. The pair magnets do not generate any rolling moment in the uniform magnetic field in any direction. As a result strong coupling among the controls of forces and moments is not expected.

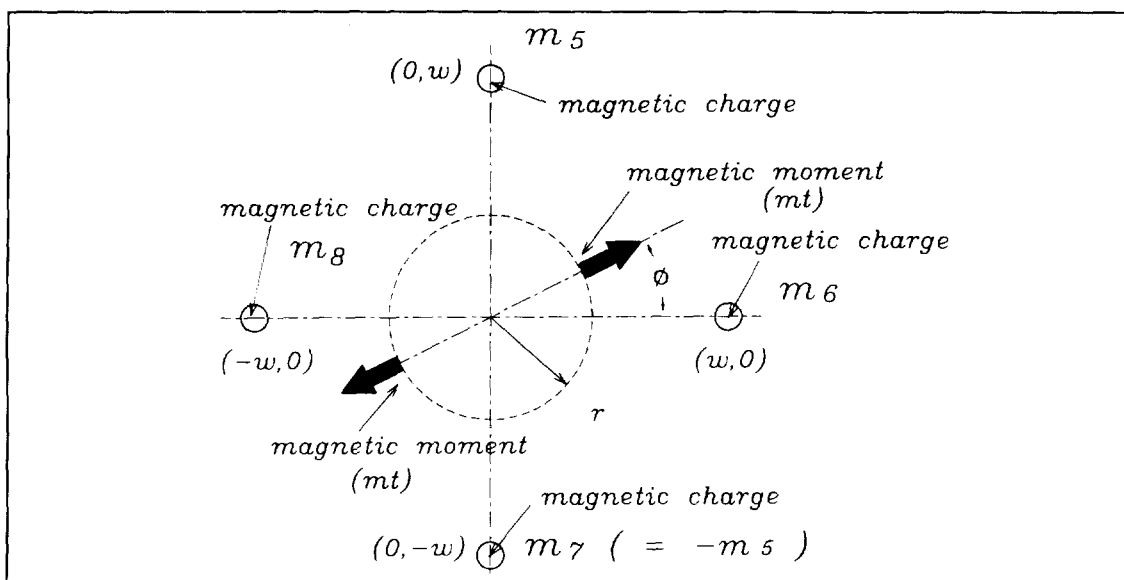

Figure 5. A model of rolling moment generation

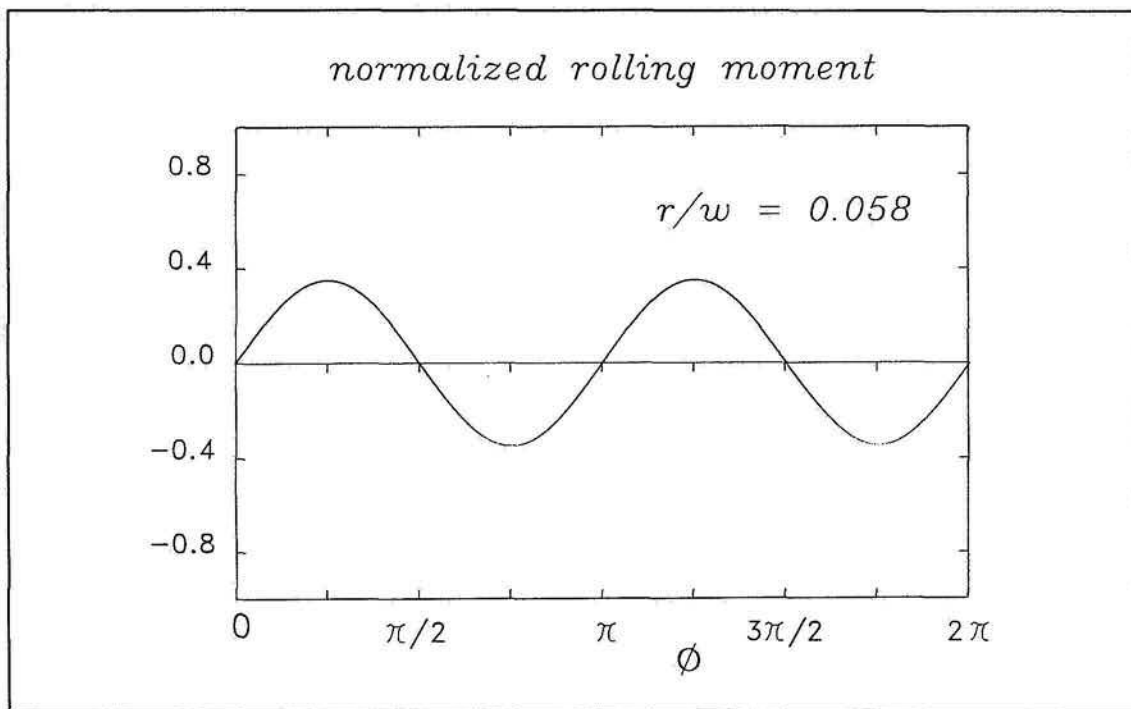

Figure 6. Estimated result

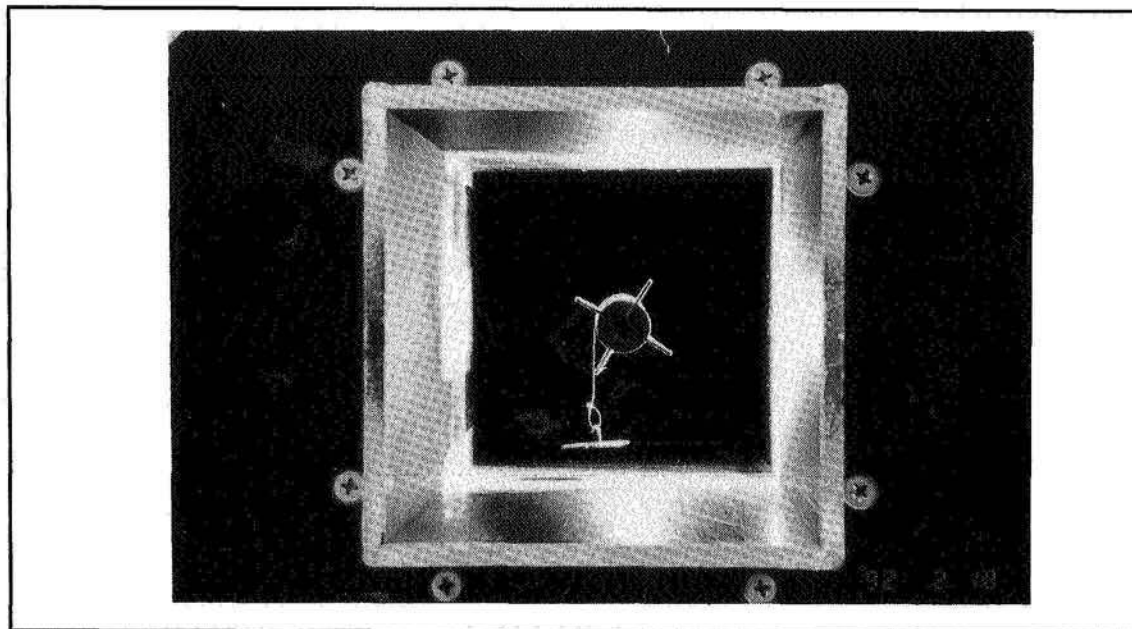

Figure 7. A model during the rolling moment calibration test

Test Results

Tests were conducted two times with different models. The model of the first test is shown in Figure 7. The model of the second test is different in the size and shape of the pair magnets. A part of the test results is shown in Figure 8. The rolling moment is controlled well. According to the figure, the relation between the rolling moment magnitude and the current for generating it are the same as expected

by the principle. Besides, the roll angle effects on the other forces and moments are also small as shown in Figure 9. Both test results look very similar to each other. As a result they show the principle of generating the rolling moment right.

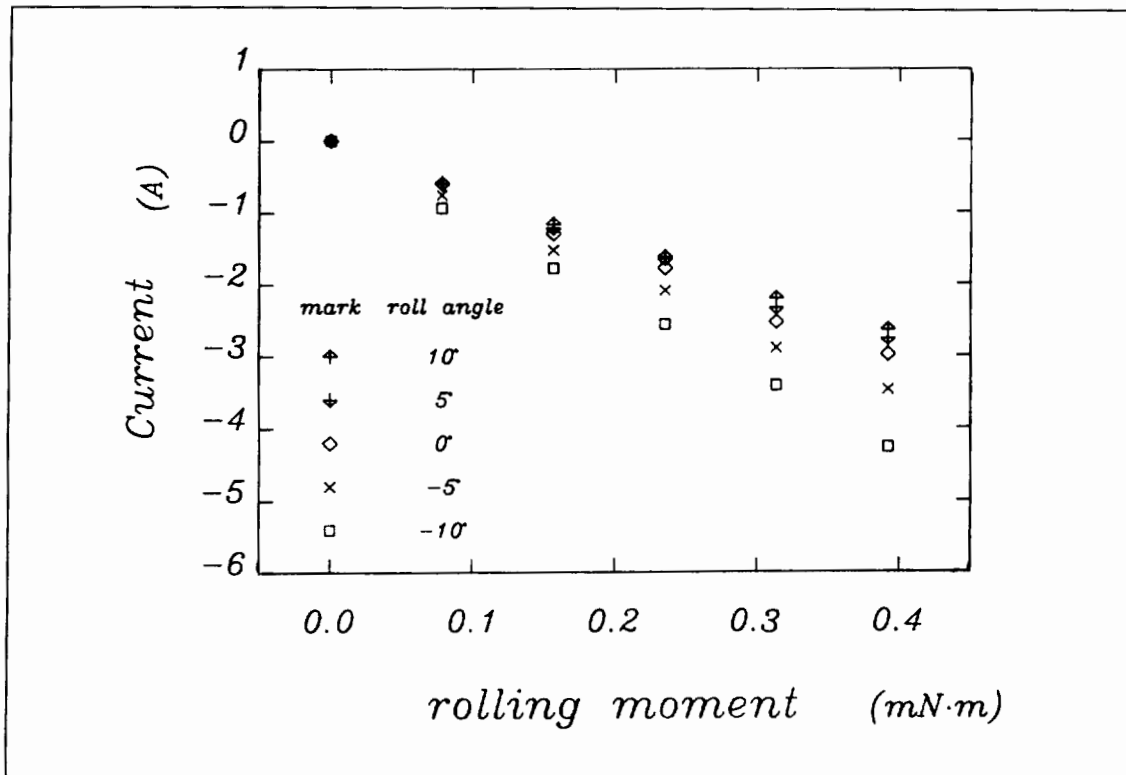

Figure 8. Rolling moment calibration test results

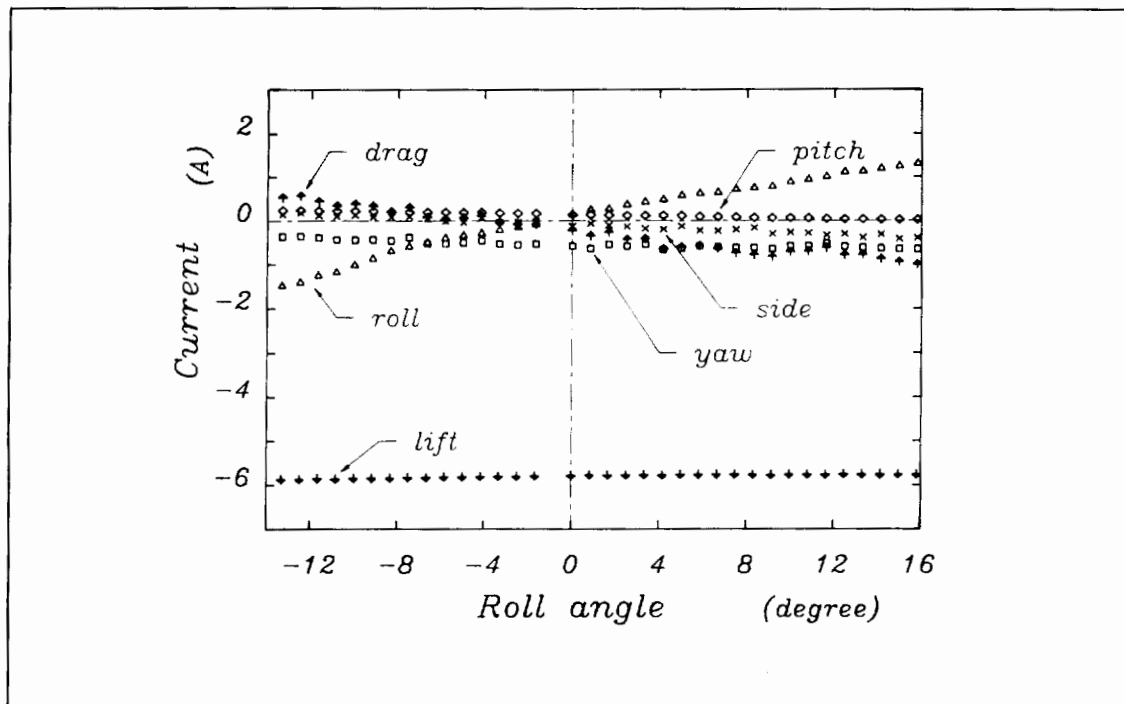

Figure 9. Coupling effects among forces and moments

Dynamic Calibration Test

Dynamic Calibration Analysis

Dynamic calibration is a very attractive way of calibrating the balance function in the MSBS. Static calibration of the MSBS is expected to be very elaborate if the model is in various attitudes. The principle of the dynamic calibration is simple. The practice of the calibration is much easier than the static one. But the obtained results do not show good accuracy compared with those by the static calibration presently. A preliminary dynamic calibration test was carried out with the 10cm MSBS.

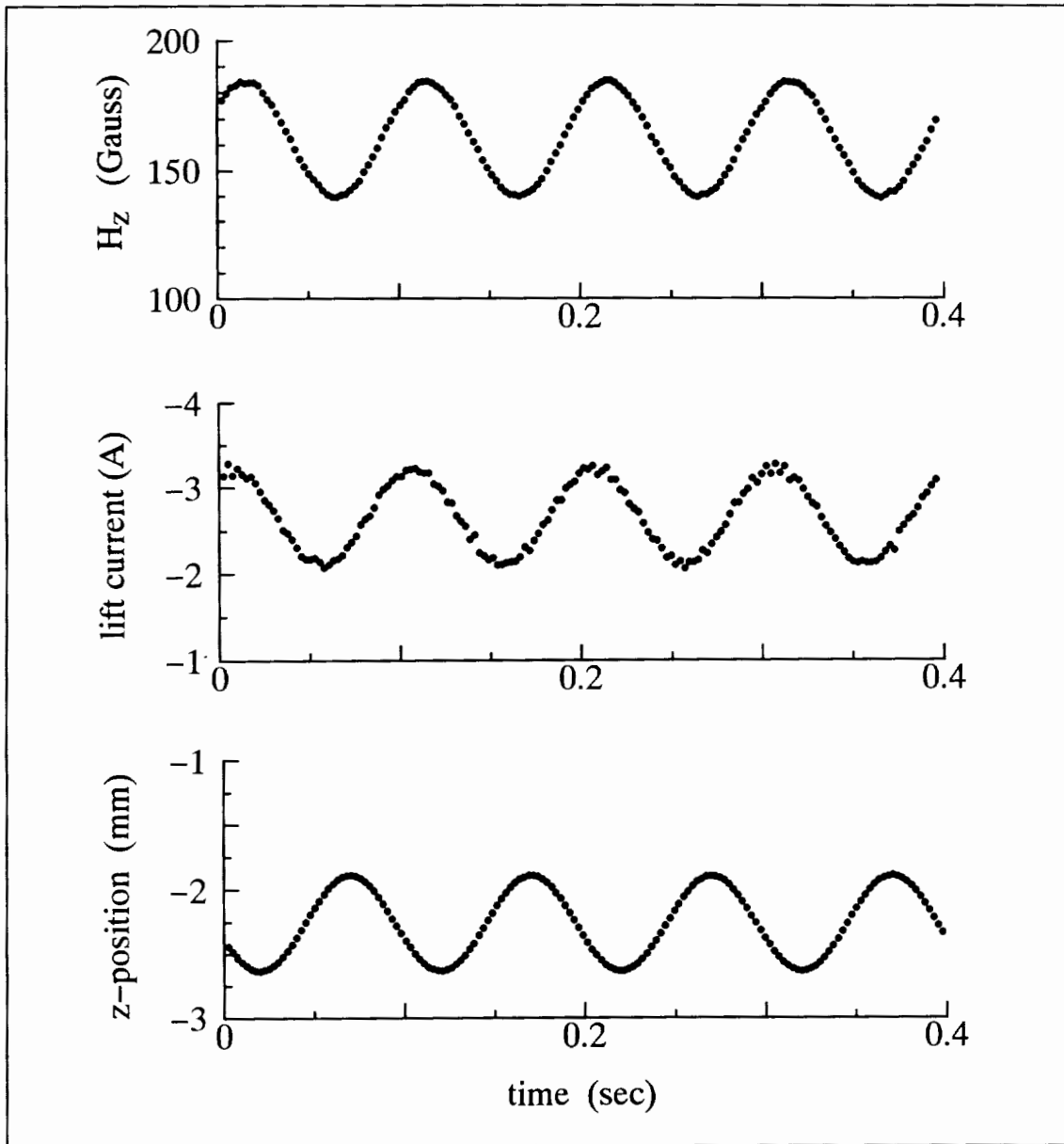

Figure 10. Measured z position and lift current at 10 Hz heaving motion

Dynamic Calibration Tests and Results

Current passing through each coil and the model position and H_z just below the coil 5 were measured in real time during a model heaving at various speeds. The model is a simple cylindrical magnet with a sheet of white paper. The magnet is 125 mm long and 10 mm in its diameter. The weight of it is 72.8 g. The control frequency is 397 H_z . The lift current is defined here as a half sum of both currents passing coils 1 and 5. The lift current does not lie on the 10 Hz sinusoidal wave so accurately as the measured z-position and H_z in Figures 10. Besides the difference in phase between z-position and the current is much larger than between z-position and H_z .

The estimated force/current constant is affected by the frequency as shown in Figure 11. The results look similar to the those in reference 7. On the contrary, the force/ H_z constant looks constant when the frequency is larger than 9 Hz. The static results are estimated from the model mass and the averaged measured H_z at each frequency. The static ones are very near the constant value of the dynamic results although there still exists a little difference between the two constants. This fact means that measuring the magnetic field intensity is superior to measuring the coil currents for the magnetic balance. Although only one H_z was measured in this preliminary test, it is more desirable to measure the magnetic field intensity at many points on the test section walls near the coils.

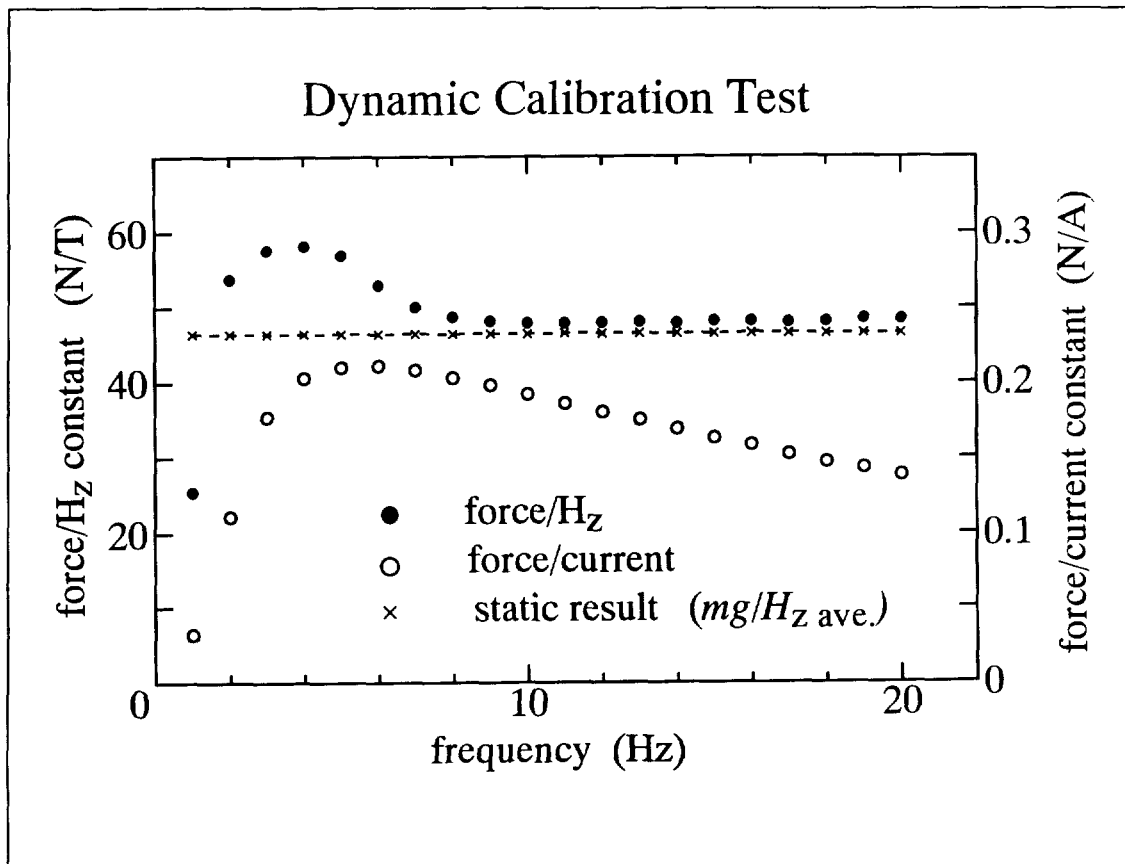

Figure 11. Dynamic calibration test results with sinusoidal motion in z

60cm MSBS

System Description

Coil Arrangement

The 60cm MSBS has 8 iron cored coils and 2 air cored coils as the 10cm MSBS. The four lift coils are subdivided into two parts in each. Constant current passes through the half part of each lift coil to generate the constant large $\partial H_z / \partial x$. The turns and sizes of the coils are listed in Table III. The assembled coils are shown in Figure 12. The positions of the coils are a little different from those of the 10cm MSBS. The drag coils are closer to each other than in the 10cm MSBS to get good efficiency of generating large $\partial H_x / \partial x$. The two sets of four iron coils at front and rear positions are closer to each other than in the 10cm MSBS. The test section of the 60cm MSBS is the largest in the world as shown in Figure 1.

coil No.	turns	core size(mm)	purpose
0, 9	50	620 x 620 air cored	drag force
1, 3, 5, 7	97+97	200 x 200 iron cored	lift force pitching moment
2, 4, 6, 8	100	200 x 200 iron cored	side force yawing moment rolling moment

Table III. Dimensions of coils of the 60cm MSBS

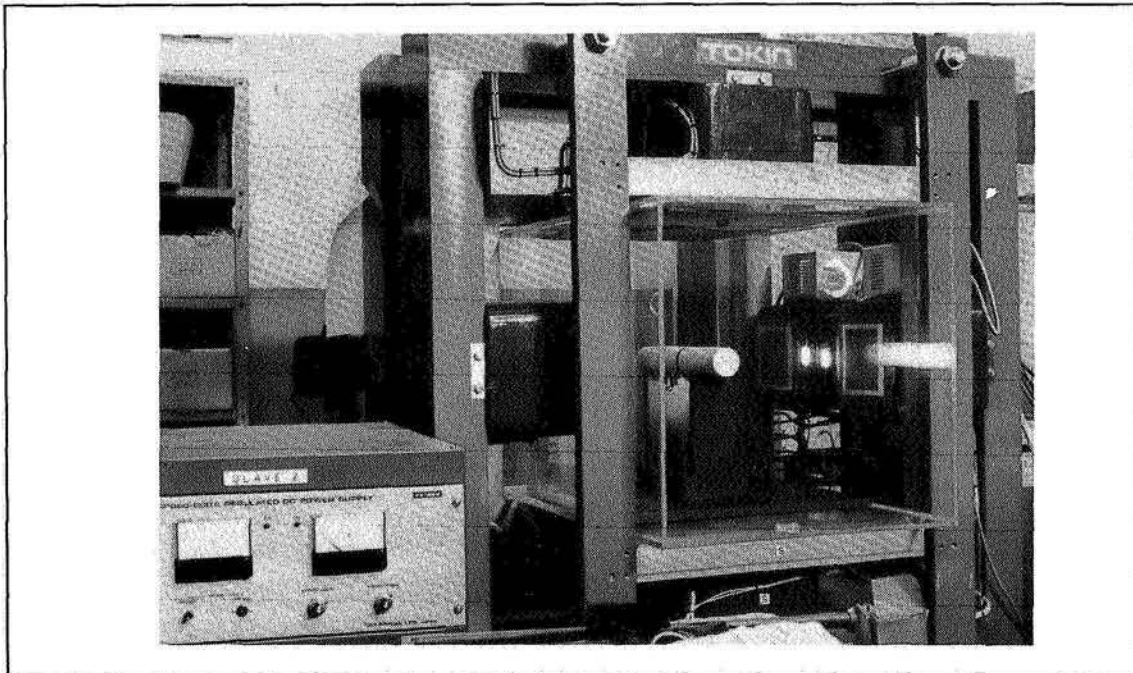

Figure 12. Assembled coils at the 60cm MSBS

Models

There is only one magnetic core for two models at the 60 cm MSBS. One model is 461.5 mm long and 60 mm in its diameter and about 1.3 kg in its weight without the magnet. It has a large room inside it for mounting some instruments. The other model is 381 mm long and 55 mm in its diameter and about 500 g in its weight. It looks similar to the other one but is much lighter. It does not have much room inside it. The permanent magnet is cylindrical and 50 mm in its diameter and 300 mm in length. The material is Fe-Ni-Co magnet and the flux of magnetic induction is 0.00238 Wb.

Model Position Sensor

The model position sensor at the 60 cm MSBS is similar to the one at 10cm MSBS. But it has a zoom lens system and adjusts the size of the image on its screen. The image size is about 1/3 of the model size. Analytical estimation shows the accuracy of the sensor does not vary with the image size except in the y position.

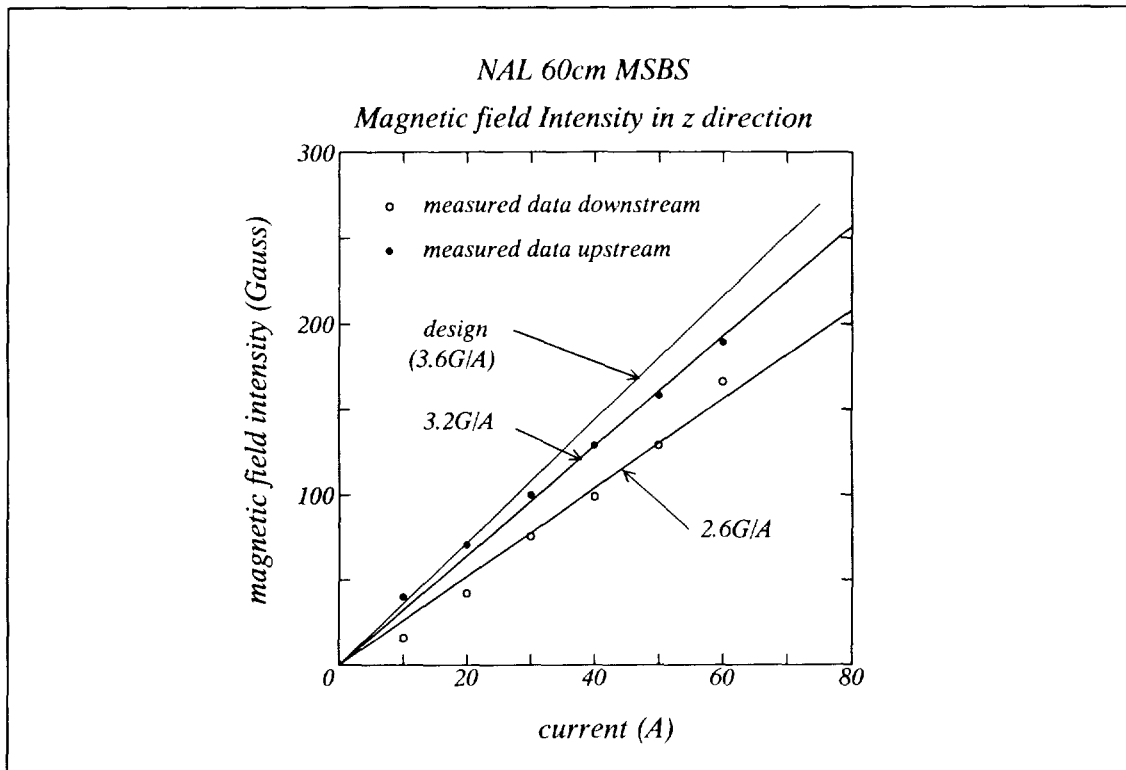

Figure 13. Measured Hz at the 60cm MSBS
Measured Magnetic Field

Power Supply

The power supply for the MSBS consists of five bipolar current control mode power units and two uni-polar power units for bias coils. The maximum current and voltage of the units are 75 A and 60 V. The forward lift coils 1 and 3 are connected to each other and are provided with current by a power unit. The pairs of coils (5,7), (2,4),

(6,8) and (0,9) are also connected in one respectively in a similar way. The 5 degree control in freedom will be available with this power supply. An extra two power units will make the control be available in 6 degrees of freedom at the MSBS as at the 10cm MSBS. The power units are controlled by voltage signals from five DA converters and monitor DC outputs of the units are available as in the 10cm MSBS. Those power units are linear. The error is within 0.1% of their full range.

Controller

The MSBS is controlled by a personal computer as in the 10 cm MSBS. The feedback control speed is 248 Hz. The control algorithm is the same as in the 10cm MSBS. There is no data acquisition computer but the model position and signal outputs for the power units are stored in its memory in real time.

The generated magnetic field intensity is weaker than that designed in the z direction by 30 %. Figure 13 shows the measured one.

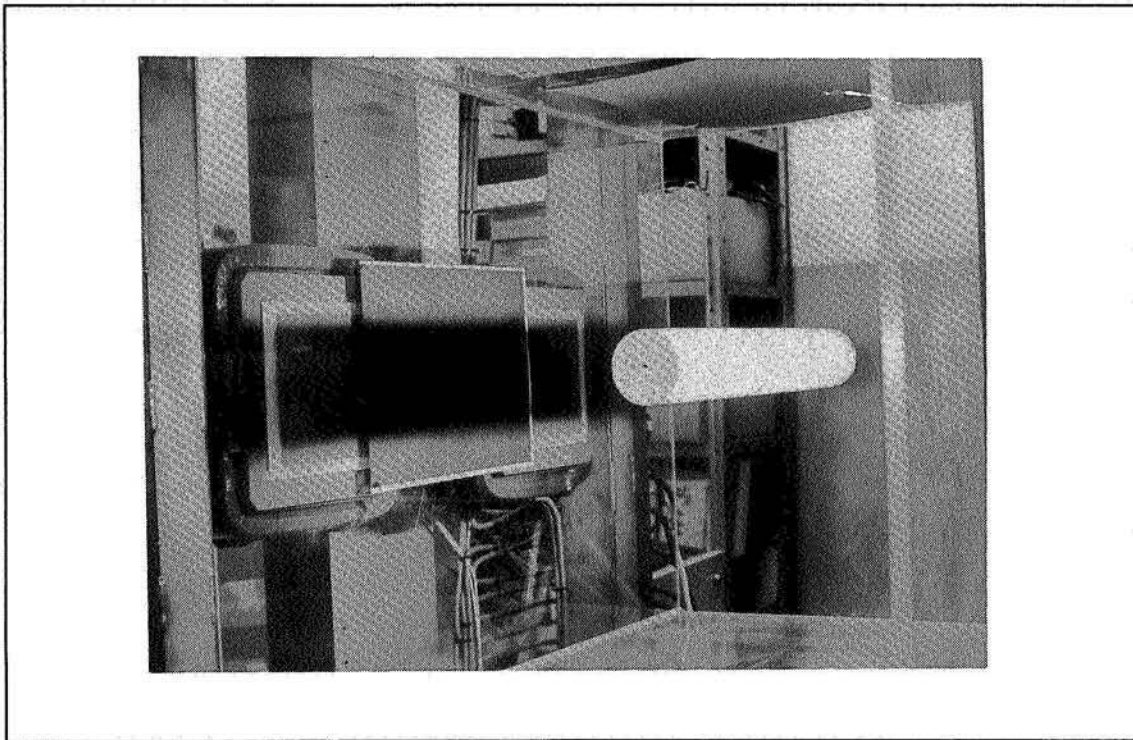

Figure 14. A suspended model at the 60cm MSBS.
Some Suspension Results

The larger model was suspended in the 60 cm MSBS in 3 degrees of freedom in the longitudinal direction. The four side coils generate the magnetic field to put the model along the center line. Figure 14 shows the model in suspension. The pitch angle and z location of the model were changed by moving and rotating the model position sensing system. The system is mounted on a stage. The stage is composed of two substages which are used for rotation and for translation in z. The system position in pitch angle and in heaving can be changed by controlling the substages independently. These tests were carried out in a very primitive sense.

REMARKS

The two magnetic suspension and balance systems are in operation at NAL. The smaller one, the 10cm MSBS, was first operated in 1987. The examination of MSBS design method and study of MSBS operation have been carried out with this MSBS. A model with two pairs of extra magnets plus a main magnet inside it can be suspended in the 6 degrees of freedom. The way of rolling moment control was examined two times with different models and the results show the way is right. A preliminary dynamic calibration test was carried out. The dynamic force calibration with the coil currents looks poor in accuracy as well as in reference 7. But the calibration with measured magnetic field intensity is very superior to that.

The larger one, the 60cm MSBS, was designed with obtained test results and experiences with the 10cm MSBS and first operated in 1993. A model with a cylindrical magnet can be suspended in the 60 cm MSBS in 3 degrees of freedom in the longitudinal direction. The measured magnetic field intensity in z direction was less than the designed one by about 30% in its magnitude. The system has 5 power supply units and it can potentially suspend a model with a cylindrical magnet in the 5 degrees of freedom. The size of it is the largest in the world.

REFERENCES

1. Kilgore, R: MSBS Newsletter, number 9, May, 1992, pp. 14
2. Kuzin, A.V.; and Vyshkov, Y.D., eds.: PROGRESS OF MAGNETIC SUSPENSION AND BALANCE SYSTEMS FOR WIND TUNNELS IN THE USSR, NASA CP 3152, August, 1991, pp. 765-774
3. Sawada, H.; and Kanda, H., eds.: Study of the 0.1m x 0.1m Magnetic Suspension and Balance System. NAL TM-623, June, 1990
4. Sawada, H.; and Kanda, H., eds.: THE 10CM X 10CM MAGNETIC SUSPENSION AND BALANCE SYSTEM AT THE NATIONAL AEROSPACE LABORATORY. AIAA 91-0397, Jan., 1991
5. Britcher, C.P.; and Goodyer, M.J., eds.: DIGITAL CONTROL OF WIND TUNNEL MAGNETIC SUSPENSION AND BALANCE SYSTEM, ICIASF'87 RECORD pp .334-341, June, 1987
6. Sawada, H.; and Suenaga, H., eds.: Rolling Moment Control in the NAL 10 cm x 10 cm Magnetic Suspension and Balance System. NAL TR-1164, June, 1992
7. Eskins, J; AN INVESTIGATION INTO FORCE/MOMENT CALIBRATION TECHNIQUES APPLICABLE TO A MAGNETIC SUSPENSION AND BALANCE SYSTEM, NASA CR 181695, August, 1988