

# Control System for a Partial Body Weight Support Device for Human Gait Training Using a Linear Motor

Jun-Ho Lee<sup>†</sup>, Paul E Allaire<sup>†</sup>, Adam C Wolovick<sup>†</sup>, Wei Jiang<sup>†</sup>  
 Patric O Riley<sup>‡</sup>, D. Casey Kerrigan<sup>‡</sup>

<sup>†</sup>Department of Mechanical and Aerospace Engineering  
 University of Virginia

E-mail: jl7e@virginia.edu, pea@virginia.edu, acw2j@virginia.edu, wj2b@virginia.edu

<sup>‡</sup> Department of Physical Medicine and Rehabilitation  
 University of Virginia

E-mail: por2n@virginia.edu, dck7b@virginia.edu

## ABSTRACT

This study is concerned with the control system design using Labview Real Time Module and Matlab/Simulink combined system for an application to the Partial Body Weight Support (PBWS) system for human gait training actuated by a linear motor moving in translation. In order to control the linear motor, a simple PI position controller which includes a translation velocity feedback loop is employed. The role of the velocity feedback loop is to improve the stiffness of system loop used in motion control of the linear motor. A control algorithm is implemented in the Matlab/Simulink and the compiled Simulink blocks source code is downloaded to the Labview Real Time Module. A steel frame necessary for supporting the patient is designed. A sinusoidal reference signal, which represents a normal person's dynamic center of mass oscillating pattern, is employed to train the patients. The success of the PBWS gait train device in rehabilitating patients depends on the device delivering the proper center of mass oscillating pattern. This paper develops a control system to make the linear motor track the center of mass oscillating pattern and demonstrates the tracking performance of the proposed control system.

## INTRODUCTION

Losing the ability to walk or to support ones own weight due to stroke or other disability has a strong impact on a persons life. The loss of mobility creates numerous problems and usually leaves the effected person much less self sufficient and more dependent upon others. Therefore gait re-education must be a major part of the rehabilitation process after a stroke or an injury which results in the loss of walking ability.

The three main groups of patients in need of gait re-education are spinal cord injured patients, stroke patients and lower limb amputees. In this paper we focus on the stroke patients. These locomotion disabilities cause a reduction in balance capability and an inability to bear one's full weight. Therefore weight bearing and the support a patient in an upright position are crucial factors to allow for walking rehabilitation to take place. A traditional method for weight bearing is to use parallel bars or assistive devices such as a walking

frame. However in these devices the amount of weight bearing cannot be controlled actively and monitored. Recently some types of PBWS system have started to come into use [2]-[7] and have showed that retaining gait in severely impaired stroke patients with a percentage of their body weight supported results in better walking and postural abilities that did gait training in patients bearing their full weight.

In this paper we introduce a new research field related to partial body weight supported (PBWS) gait training and rehabilitation of stroke patients using a actively controlled linear translation motor which is powered by an electromagnet. The PBWS system has the objective of training a patient who has difficulty walking because of various neurologic injuries, such as stroke, spinal cord injury and traumatic brain injury. In the control system, the reference model modeling the normal human walking pattern is defined by the center of mass (CoM) displacement and a desired pattern of support force that is developed by the clinical team for a treatment of a particular patient. The pattern will be imposed by the actively controlled PBWS system using a linear motor/cable/pulley system connected to the body through a suspension harness. In addition, the system will measure both the support force, instantaneously through a load cell in the upper cable support, and the CoM position through a position sensor provided with the active linear motor. This produces the direct measurement of two very important additional gait measured parameters that have often not been obtained in previous PBWS experiments. They also can be employed as diagnostic tools.

The PBWS system includes a linear servo motor, a stiff aluminum frame, and all the mechanisms to interface the patient to the linear motor: i.e. the body support harness, its cable attachment, the pulleys and the cable. A simple PI Com position controller that includes a velocity loop [1] is designed using the Matlab Simulink platform and the compiled c-code is downloaded to National Instruments Labview hardware [8]. The linear motor used in this PBWS system was supplied by California Linear Devices, Inc. 50204A with a forced air-cooling system. This linear motor can produce up to 3300[N] peak force, and 2025[N] continuous force. The force sensitivity, the capability to produce a force per amp, is 133[N/Amp]. Each component will be discussed in detail in the next sections.

In this paper first we evaluate a mathematical model of the

linear motor and then develop a control system using Matlab/Simulink and Labview Real Time Module. Secondly we show a PI controller with a velocity feedback loop control in blocks. Finally measured results are obtained from suspending a simple mass with the system to create system CoM movement through a desired oscillatory path.

## APPARATUS of PBWS SYSTEM

Fig. 1 shows a conceptual drawing of the PBWS system.

### • Linear Motor

For the PBWS system we employed a linear motor of California Linear Devices, Inc. Fig. 2 and 3 represent the linear motor and a tubular type motor shaft. The design of the linear motor incorporates three-phase, brushless DC technology and rare earth neodymium-iron-boron permanent magnets wrapped around the shaft's periphery. This tubular type approach of the shaft increases the electromagnetic interaction which takes place over the shaft's full 360° surface area, resulting in a high force-to-volume linear motion solution, unlike a conventional linear actuator whose rotor lies flat and is then formed into a rectangular tube. Table 1 shows the

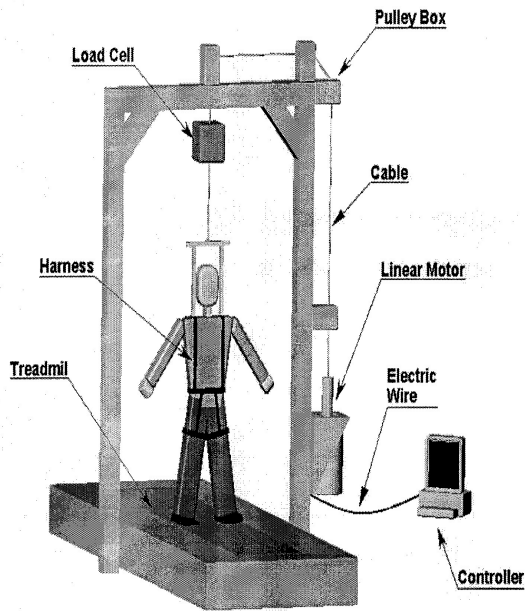

Fig. 1. Partial Body Weight Support System

parameter values of the linear motor.

### • Mathematical Model of the Linear Motor

The equation of motion of the linear motor is

$$m\ddot{x} + c_m\dot{x} = f = k_i i \quad (1)$$

where  $m$  is the weight of the motor shaft,  $c_m$  is the mechanical damping coefficient,  $f$  is the force produced by the linear motor,  $k_i$  is the motor torque coefficient,  $i$  is the coil current.

TABLE I  
LINEAR MOTOR PARAMETERS

Parameter	Value
Coil inductance $L$	50[H]
Coil resistance $R$	3.28[Ω]
Back emf coefficient $k_b$	122[V-s/m]
Motor torque coefficient $k_i$	135[N/A]
Max continuous force(holding) $f_c$	2025[N]
Peak force $f_p$	3300[N]
Shaft stroke length $L_s$	0.25[m]

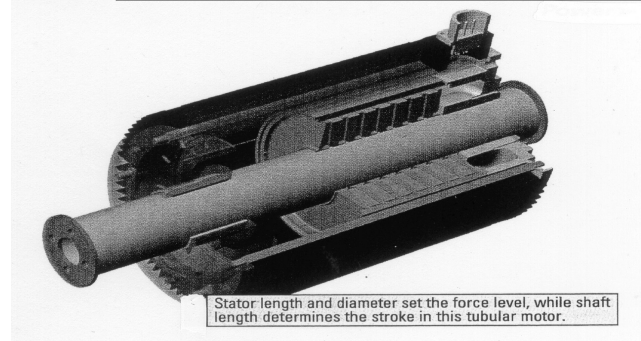

Fig. 2. Linear Motor

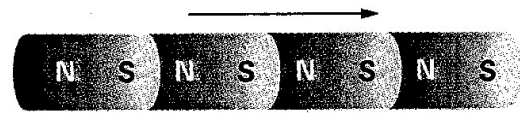

Fig. 3. Tubular type motor shaft

A well known electrical circuit equation for the linear motor is expressed such as:

$$E = Ri + L \frac{di}{dt} + k_b \dot{x} \quad (2)$$

where  $E$  is the input voltage,  $R$  is the coil resistance,  $L$  is the coil inductance,  $k_b$  is the back emf coefficient,  $\dot{x}$  is the velocity of the motor shaft. Equation (1) and (2) yields the state space model that is

$$\begin{bmatrix} \dot{x} \\ \ddot{x} \\ i \end{bmatrix} = \begin{bmatrix} 0 & 1 & 0 \\ 0 & -\frac{c_m}{m} & \frac{k_i}{m} \\ 0 & -\frac{k_b}{L} & -\frac{R}{L} \end{bmatrix} \begin{bmatrix} x \\ \dot{x} \\ i \end{bmatrix} + \begin{bmatrix} 0 \\ 0 \\ \frac{1}{L} \end{bmatrix} E \quad (3)$$

### • Controller

A proportional-integral (PI) position controller that has velocity feedback loop is used to make the motor shaft follow the predefined CoM sinusoidal trajectory. A safety loop is included in the control block. The safety loop continuously monitors an emergency signal and protects a patient from unexpected behavior of the motor or releases a patient from an uncomfortable status. Fig. 4 shows the overall block diagram of the controller including the safety loop. In this figure a signal generator produces a reference signal which represents

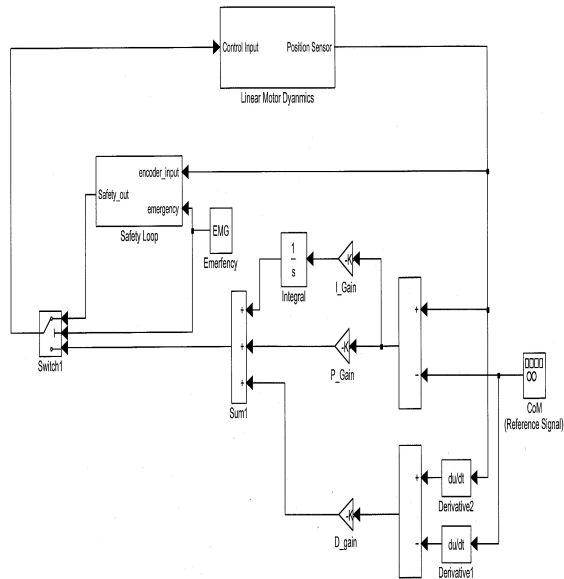

Fig. 4. Control Block Diagram

a normal person's dynamic center of mass oscillating pattern. The feedback gains  $P_{Gain}$  and  $D_{Gain}$  retain their meaning as a active stiffness and a active damping relative to the desired position and velocity states. These two terms increase the dynamic stiffness and damping by adding to the passive (mechanical) damping in the form

$$\text{Dynamic Stiffness} = \frac{F_d}{x} = m s^2 + (c_m + D_{Gain})s + P_{Gain} \quad (4)$$

where  $F_d$  is the sum of the external disturbances. In addition to the command inputs for position and velocity, the controller also includes an additional controller state: that of integrated position error  $\int x_{error} dt$ . The command value of this state is always zero, meaning no accumulated error is desired. This additional integrator assures that no steady-state position error is present if constant disturbances are present.

#### • Frame and Cable Guide

Fig. 5 and 6 shows frame to support the patient and the cable guide to avoid swinging of the loadcell (see Fig. 1 and 5) which is installed above the cable guide during patient walking. In order to construct the frame we employed the  $0.076[m] \times 0.15[m]$  aluminum material rectangular tubes. The frame dimensions are  $3.3[m]$  in height to accomodate a person up to  $1.8[m]$ ,  $2[m]$  in width to fit over the treadmill which is used to train the patients gait movement. The deformation of the top bar is about  $1.27 \times 10^{-4}[m]$  under the  $90[Kg]$  load. The purpose of the cable guide shown in Fig. 6 is to prevent input error of the loadcell from unexpected swinging of the cable during patient movement. Thus by using this device the loadcell always can read the vertical force acting on the loadcell even if the patients moves back and forth or left side and right side during the training.

#### • Loadcell

The loadcell is employed for force control of the PBWS system. The predefined percentage of the weight relief from the patients weight as specified by medical personnel is used for the vertical force control, which is a reference signal. The loadcell input signal is the force that should be relieved from the patients weight. The rest of the patients weight is supported by the patient. Thus the force control of the PBWS system is designed to make the output force of the linear motor track the reference force profile, such as position tracking control.

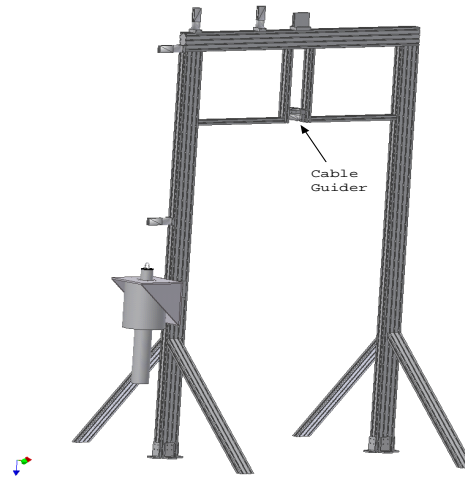

Fig. 5. Frame to support the patient

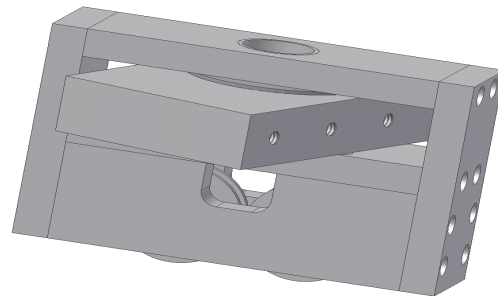

Fig. 6. Cable Guide

## EXPERIMENTAL SETUP

A combined system which has Matlab/Simulink and Labview Real Time Module is used to implement the position control algorithm tracking a reference signal. Matlab/Simulink is well known software to control engineers and the Labview Real Time Module is a hardware board of National Instruments, involving data acquisition, A/D, and D/A conversion, being used in many engineering applications. Fig. 7 shows the signal flow between Matlab/Simulink and Labview Real Time Module. The Simulation Interface Toolkit (SIT) including the SIT Server provides a way to create a Labview user interface that we can use to interact with a Simulink model by way of the

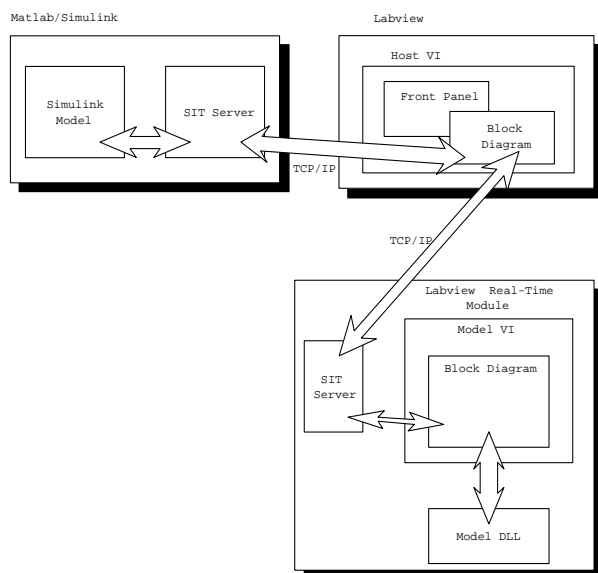

Fig. 7. Running a simulink model on an RT target

TCP/IP communication port. Thus using the SIT Connection Manager dialog box of Labview, we can specify the relationship between the Labview controls and indicators of the front panel and the Simulink parameters and sink blocks. Once we configure the relations between the Simulink and the Labview, the Simulation Interface Toolkit automatically generates the block diagram code necessary to establish the relationships between the Labview VI and the Simulink model.

The simulink model blocks which express the position control algorithm are converted into a dynamic link library (DLL) that Labview can call, by way of the Real Time Workshop that is the Simulink compiling process, then the Simulink model DLL is downloaded to the Labview Real Time Target Module. During this process the Simulation Interface Toolkit of the Labview automatically builds a model VI that call the Simulink model DLL. Once the Simulink model DLL is downloaded to the Labview Real Time Target and overall communication loop between the Labview VI and the Simulink model DLL, Simulink model no longer requires Matlab/Simulink to run because the Simulink model DLL contains all aspects of the control algorithm.

There are several advantages in this implementation method compared to the conventional method such as using a DSP chip.

1. Shorten development time.
  - (a). Easy gain tuning in real time.
  - (b). Direct implementation of the simulink model: Not necessary to write C-codes.
  - (c). Easy data acquisition: Not necessary the have physical probes and oscilloscope.
  - (d). Easy debugging by monitoring in real time all output signals for each of the simulink model blocks.
2. No necessary to understand Labview language.
3. User friendly GUI (Graphic User Interface).

A commercial programmable (MP-FLX 230, MTS System Co.) pulse width modulated servo amplifier is employed to amplify the control output signal. The PWM switching frequency of the amplifier is 20[kHz] and maximum output volt-

age is  $\pm 10[V]$ .

## EXPERIMENTAL RESULTS

In this section we show the experimental results for the PBWS system connecte to the linear motor with a 10[kg] weight by the cable. The purpose of the experimentation is to test our test controller which is designed to be followed the reference trajectory and to test the safety loop.

### • Tracking Performance

For a tracking performance test, the gains of the test controller, that is Proportional-integral (PI) including a velocity loop, are  $P_{Gain} = -300$ ,  $I_{Gain} = -200$ ,  $D_{Gain} = -40$ . The sine and square wave functions which have 0.5[Hz] frequency and  $\pm 0.03[m]$  amplitude are used as reference trajectory. These reference signal are produced by the Matlab/Simulink Signal Generator block. Figs. 8 - 10 show

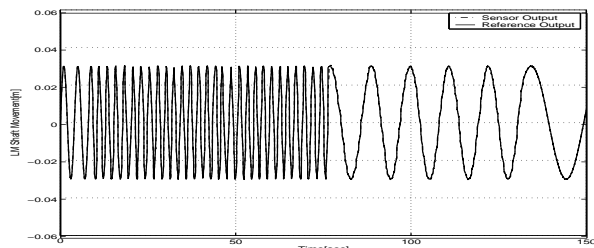

Fig. 8. Linear Motor Shaft Movement with 10[Kg] Weight

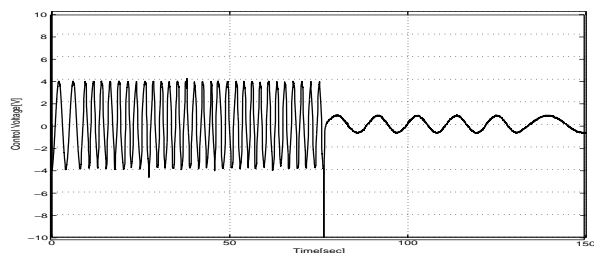

Fig. 9. Control Voltage

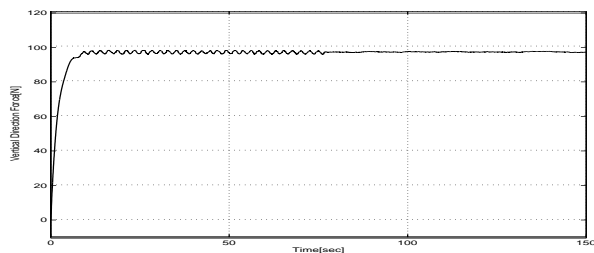

Fig. 10. Vertical Direction Force acting on the Linear Motor

the experimental results when we applied a 0.5[Hz] frequency,  $\pm 0.03[m]$  amplitude sine wave function as a CoM reference signal. The frequency of the sine wave is changed from 0.5[Hz] to 0.1[Hz] in real time at about 75[sec] to test the trajectory following capability of the linear motor. In Fig. 8 we see significantly good tracking performance of the linear motor even

when there is frequency change. The number of peaks between 0[sec] and 50[sec] are 20 peaks, which should be 25 peaks. This is because of the 0.1[sec] time delay when the Labview writes the measured data into the RAM memory. The control voltage in Fig. 9 decreases from 4[V] to 1[V] due to the speed change. Fig 10. represents the vertical direction force action on the linear motor. This figure shows the constant force (98[N]) measured by the loadcell in the presence of an up and down movement of the weight. Figs. 11 - 13 are the experimental

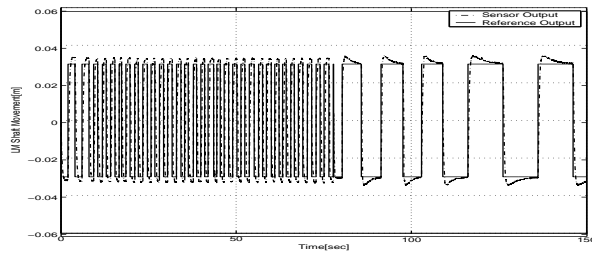

Fig. 11. Linear Motor Shaft Movement with 10[Kg] Weight

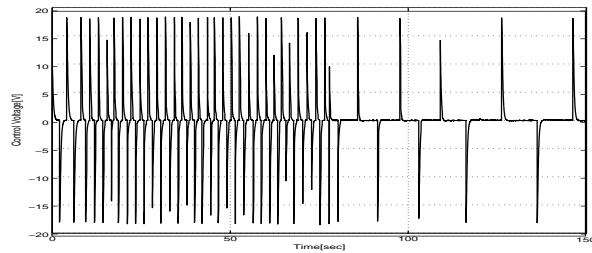

Fig. 12. Control Voltage

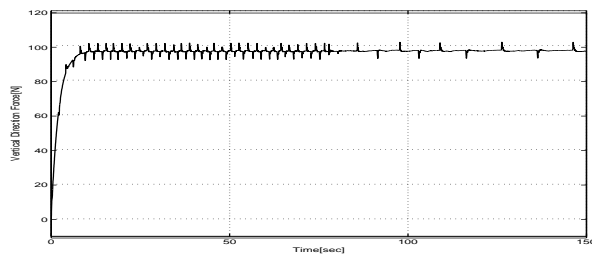

Fig. 13. Vertical Direction Force acting on the Linear Motor

test results when the 0.5[Hz] frequency and  $\pm 0.03$ [m] amplitude square wave reference function is used. In these figures, good tracking performance is shown, however when the speed of the CoM reference function is changed peak overshoots are observed in the control voltage and in the loadcell output.

• Safety Loop

The system needs to guarantee that the patient will not fall and also needs to guarantee a comfortable training status. For this purpose we add a safety control loop by monitoring an emergency signal that is produced by pushing an emergency button. The emergency button is pushed by the therapist if needed. The control loop gains of the safety loop are  $P_{Gain} = -150$ ,  $I_{Gain} = -20$ ,  $D_{Gain} = -50$ , and employ a normal step function or ramp function to remove the bump in the control voltage when the control loop is changed to the safety loop.

Figs 14 - 16 shows the linear motor shaft movement with the normal step reference function which has the amplitude 0.05[m] for the safety loop, control voltage and the loadcell output signal with 10[kg] weight. In Fig. 14 the safety loop is turned on by the emergency signal input at 13[sec] and keeps the patient's position for about 8[sec] in the stopped position, then the linear motor sends the patient to the 0.05[m] downward position (i.e., upward of the linear motor) which has been assumed as patient's comfortable standing position. However in this experimentation we observed a large bump signal in the control voltage that is shown in Fig. 15, and makes a noise sound that probably scares the patient. Fig. 16 shows the output signal of the loadcell with the 10[kg] weight. In this figure we see constant measured force. Fig. 17 represents a

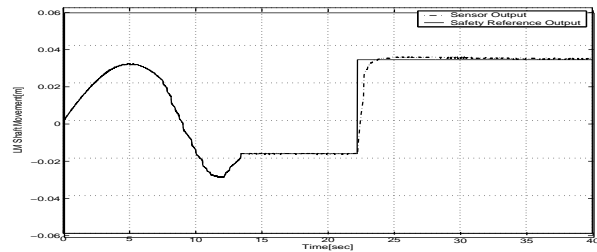

Fig. 14. Linear Motor Shaft Movement in the Safety Loop with Step Function

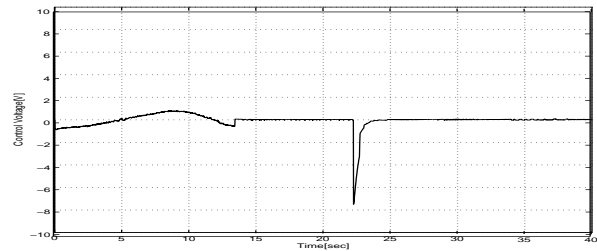

Fig. 15. Control Voltage

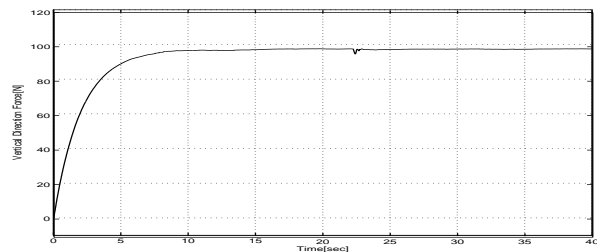

Fig. 16. Vertical Direction Force acting on the Linear Motor

reference step function with 0.017[m/sec] ramp function. By adding the ramp function we get a bumpless control voltage shown in Fig. 18, which makes a smooth transition from the position tracking control to the safety tracking control. Fig. 19 is the loadcell output signal with the 10[kg] weight which also has the good constant measured force value.

CONCLUSIONS

In this paper we showed the design of the PBWS devices and the control system. First we showed the apparatus of the PBWS system which includes the frame to support the patient and the linear motor used as a training actuator for the patient. Secondly the control devices that are combined Matlab/Simulink and Labview Real Time Module has been introduced. Finally the experimental results show accurate reference signal position tracking performance and good performance of the safety loop which gives the feasibility to the proposed system when the system is applied to actual training of the patient. The next challenging issue is to design a controller that is able to reject disturbances, which are produced by the patient.

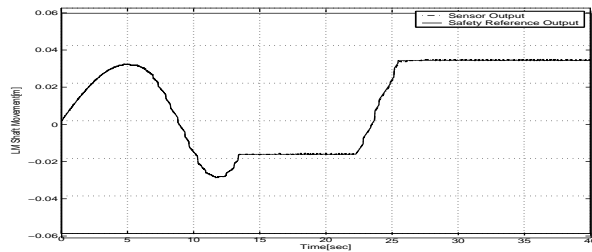

Fig. 17. Linear Motor Shaft Movement in the Safety Loop with Ramp Function

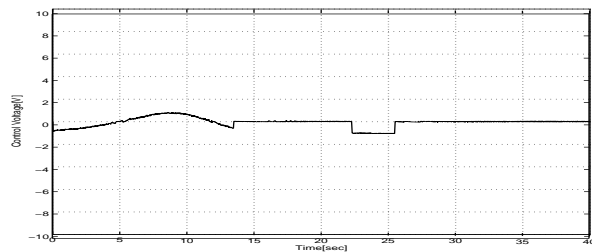

Fig. 18. Control Voltage

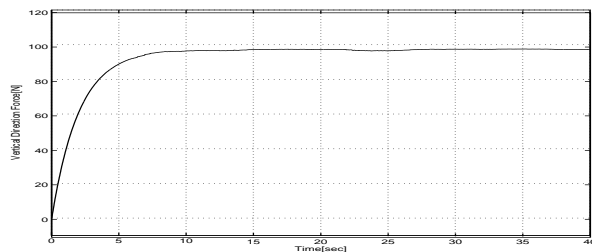

Fig. 19. Vertical Direction Force acting on the Linear Motor

and *Biological Engineering and Computing*, Vol. 25, pp. 341-344, 1987.

3. T. Pillar, R. Dickstein, Z. Smolinski, "Walking reeducation with partial relief of body weight in rehabilitation of patients with locomotor disabilities", *Journal of Rehabilitation Research and Development*, Vol. 28, No. 4, pp. 47-52, 1991.
4. V. Martha, H. Barbeau, N. Korner-Bitensky, N. Mayo, "A new Approach to Retain Gait in Stroke Patients Through Body Weight Support and Treadmill Stimulation", *Stroke*, Vol. 29(6), pp. 1122-1128, 1998.
5. M. Visintin, H. Barbeau, "The Effects of Body Weight Support on the Locomotor Pattern of Spastic Paretic Patients", *Can. J. Neurol. Sci.* Vol. 16, pp. 315-325, 1989.
6. H. Barbeau, M. Visintin, "Optimal Outcomes Obtained With Body-Weight Support Combined with Treadmill Training in Stroke Subjects", *Arch. Phys. Med. Rehabil.*, Vol. 84, pp. 1458-1465, 2003.
7. A. Searle, "Motorised Overhead Harness", *REHAB Tech - Monash Rehabilitation Technology Research Unit*
8. "Labview Simulation Interface Toolkit User Guide", *National Instruments*

## REFERENCES

1. Peter B. Schmidt, Robert D. Lorenz, "Design Principles and Implementation of Acceleration Feedback to Improve Performance of dc Drives", *IEEE Transactions on Industry Applications*, Vol. 28, No. 3, pp. 594-599, 1992.
2. H. Barbeau, M. Wainberg, L. Finch, "Description and application of a system for locomotor rehabilitation", *Medical*